

## SYSMAC CP-series CP1E CPU Units

### CP1E-E□□D□-□

### CP1E-N□□D□-□/NA20D□-□

## The CP1E Package PLCs: Economical, Easy to use, and Efficient

- The E-type Basic CPU Units provide cost performance and easy application with only basic functionality.
- The N and NA-types Application CPU Units support Programmable Terminal connection, position control, and inverter connection

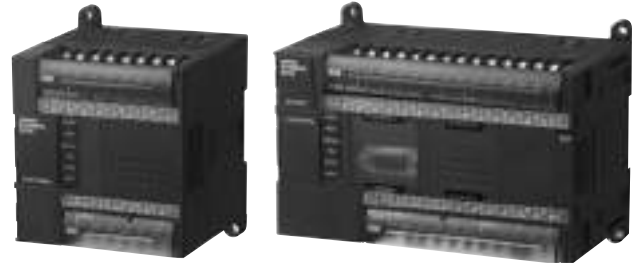

CP1E-E20DR-A

CP1E-N40DR-A

## Features

- Programming, setting, and monitoring with CX-Programmer.
- Easy connection with computers using commercially available USB cables
- With E30/40, N30/40/60 or NA20 CPU Units, Add I/O by Connecting Expansion I/O Units.
- With E30/40, N30/40/60 or NA20 CPU Units, Add Analog I/O or Temperature Inputs by Connecting Expansion Units.
- Quick-response inputs
- Input interrupts
- Complete High-speed Counter Functionality.
- Versatile pulse control for Transistor Output for N14/20/30/40/60 or NA20 CPU Units.
- PWM Outputs for Transistor Output for N14/20/30/40/60 or NA20 CPU Units.
- Built-in RS-232C Port for N/NA-type CPU Units.
- Mounting Serial Option Boards to N30/40/60 or NA20 CPU Units.
- Built-in analog I/O, two inputs and one output, for NA-type CPU Units.

# CP1E-E□□D□-□ CP1E-N□□D□-□/NA20D□-□

## System Configuration

### Basic System Configuration Using an E-type CPU Unit

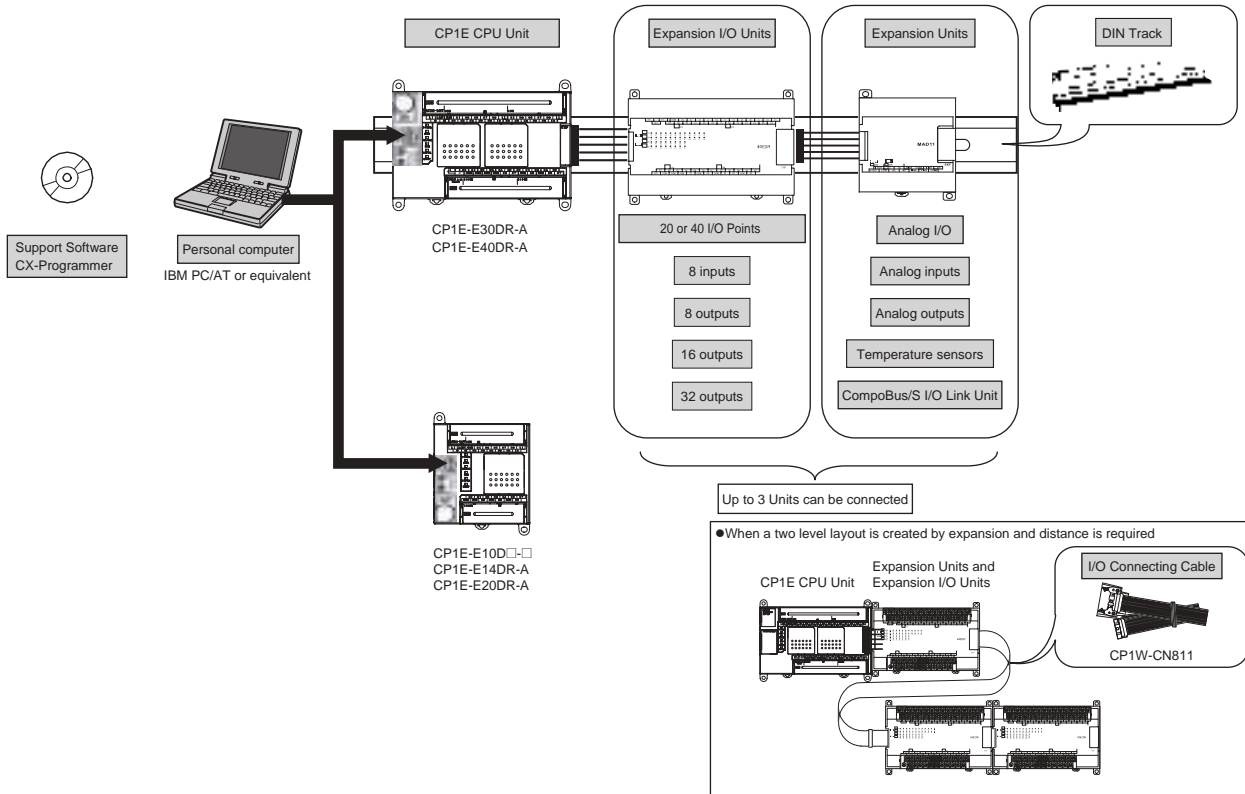

### Basic System Configuration Using an N/NA-type CPU Unit

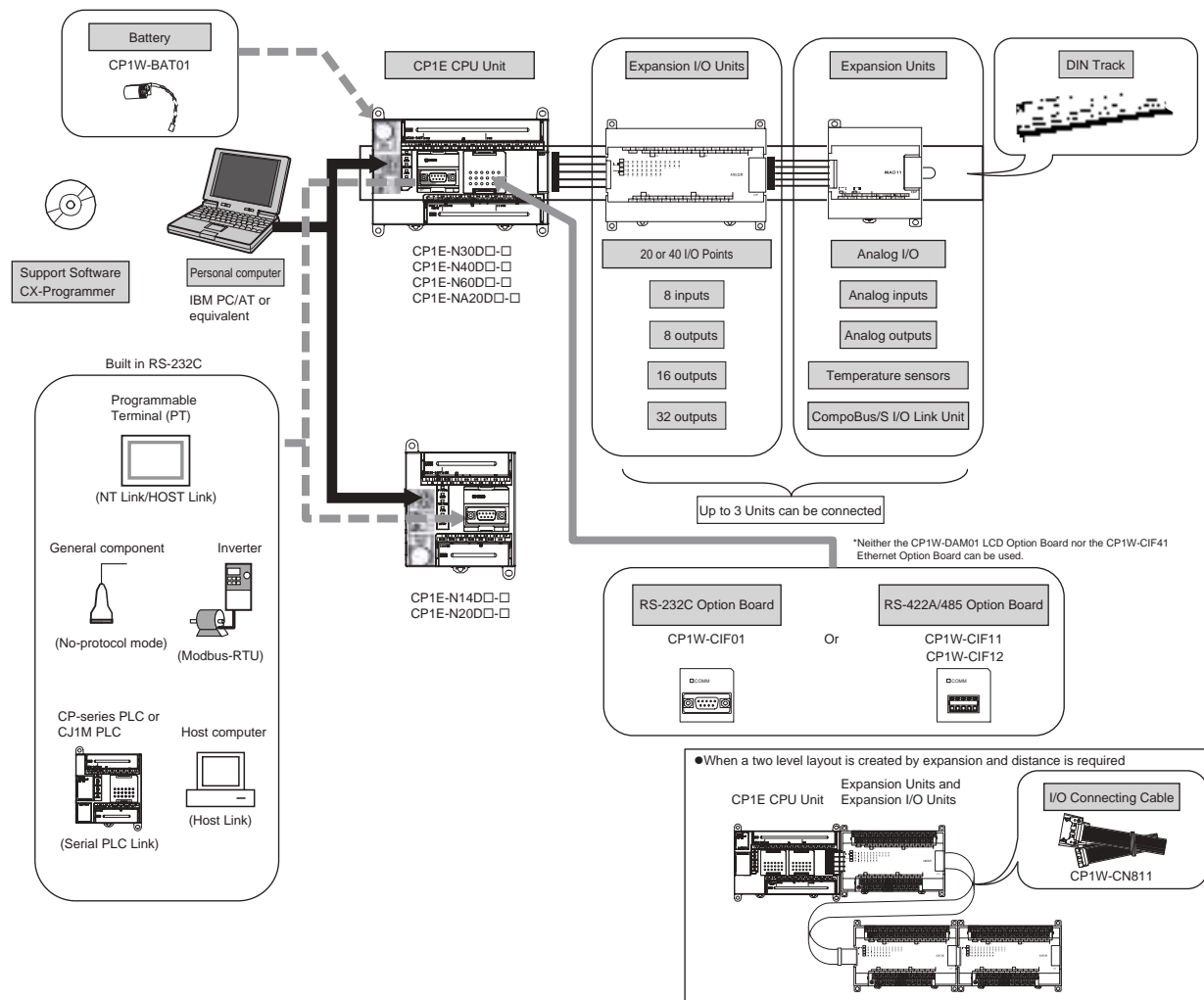





## Ordering Information

### International Standards





- The standards are abbreviated as follows: U: UL, U1: UL (Class I Division 2 Products for Hazardous Locations), C: CSA, UC: cULus, UC1: cULus (Class I Division 2 Products for Hazardous Locations), CU: cUL, N: NK, L: Lloyd, and CE: EC Directives.
- Contact your OMRON representative for further details and applicable conditions for these standards.



### E-type CP1E CPU Units (Basic Models)

Product name	Specifications						External power supply (24 VDC) (A)	Current consumption (A)		Model	Standards
	Power Supply	Inputs	Outputs	Output type	Program capacity	Data memory capacity		5 V	24 V		
<b>E-type CPU Units with 10 I/O Points</b> 	100 to 240 VAC	6	4	Relay	2K steps	2K words	--	0.08	0.04	CP1E-E10DR-A <b>NEW</b>	CE
				Transistor (sinking)			--	0.11	--	CP1E-E10DT-A <b>NEW</b>	
				Transistor (sourcing)			--	0.11	--	CP1E-E10DT1-A <b>NEW</b>	
	24 VDC			Relay			--	0.08	0.04	CP1E-E10DR-D <b>NEW</b>	
				Transistor (sinking)			--	0.11	--	CP1E-E10DT-D <b>NEW</b>	
				Transistor (sourcing)			--	0.11	--	CP1E-E10DT1-D <b>NEW</b>	
<b>E-type CPU Units with 14 I/O Points</b> 	100 to 240 VAC	8	6	Relay	2K steps	2K words	--	0.16	0.07	CP1E-E14DR-A <b>NEW</b>	CE
<b>E-type CPU Units with 20 I/O Points</b> 	100 to 240 VAC	12	8	Relay	2K steps	2K words	--	0.17	0.08	CP1E-E20DR-A	
<b>E-type CPU Units with 30 I/O Points</b> 	100 to 240 VAC	18	12	Relay	2K steps	2K words	0.30	0.17	0.07	CP1E-E30DR-A	N, L, CE
<b>E-type CPU Units with 40 I/O Points</b> 	100 to 240 VAC	24	16	Relay	2K steps	2K words	0.30	0.17	0.09	CP1E-E40DR-A	

**Note:** There are no accessories included with E-type CP1E CPU Units. A Battery (CP1W-BAT01) cannot be used.

**N/NA-type CP1E CPU Units (Application Models)**

Product name	Specifications						External power supply (24 VDC) (A)	Current consumption (A)		Model	Standards
	Power Supply	Inputs	Outputs	Output type	Program capacity	Data memory capacity		5 V	24 V		
<b>N-type CPU Units with 14 I/O Points</b> 	100 to 240 VAC	8	6	Relay	8K steps	8K words	--	0.17	0.07	CP1E-N14DR-A <b><u>NEW</u></b>	CE
				Transistor (sinking)			--	0.22	0.02	CP1E-N14DT-A <b><u>NEW</u></b>	
				Transistor (sourcing)			--	0.22	0.02	CP1E-N14DT1-A <b><u>NEW</u></b>	
	24 VDC			Relay			--	0.17	0.07	CP1E-N14DR-D <b><u>NEW</u></b>	
				Transistor (sinking)			--	0.22	0.02	CP1E-N14DT-D <b><u>NEW</u></b>	
				Transistor (sourcing)			--	0.22	0.02	CP1E-N14DT1-D <b><u>NEW</u></b>	
<b>N-type CPU Units with 20 I/O Points</b> 	100 to 240 VAC	12	8	Relay	8K steps	8K words	--	0.18	0.08	CP1E-N20DR-A	N, L, CE
				Transistor (sinking)			--	0.23	0.02	CP1E-N20DT-A	
				Transistor (sourcing)			--	0.23	0.02	CP1E-N20DT1-A	
	24 VDC			Relay			--	0.18	0.08	CP1E-N20DR-D	
				Transistor (sinking)			--	0.23	0.02	CP1E-N20DT-D	
				Transistor (sourcing)			--	0.23	0.02	CP1E-N20DT1-D	
<b>N-type CPU Units with 30 I/O Points</b> 	100 to 240 VAC	18	12	Relay	8K steps	8K words	0.30	0.21	0.07	CP1E-N30DR-A	N, L, CE
				Transistor (sinking)			0.30	0.27	0.02	CP1E-N30DT-A	
				Transistor (sourcing)			0.30	0.27	0.02	CP1E-N30DT1-A	
	24 VDC			Relay			--	0.21	0.07	CP1E-N30DR-D	
				Transistor (sinking)			--	0.27	0.02	CP1E-N30DT-D	
				Transistor (sourcing)			--	0.27	0.02	CP1E-N30DT1-D	
<b>N-type CPU Units with 40 I/O Points</b> 	100 to 240 VAC	24	16	Relay	8K steps	8K words	0.30	0.21	0.09	CP1E-N40DR-A	N, L, CE
				Transistor (sinking)			0.30	0.31	0.02	CP1E-N40DT-A	
				Transistor (sourcing)			0.30	0.31	0.02	CP1E-N40DT1-A	
	24 VDC			Relay			--	0.21	0.09	CP1E-N40DR-D	
				Transistor (sinking)			--	0.31	0.02	CP1E-N40DT-D	
				Transistor (sourcing)			--	0.31	0.02	CP1E-N40DT1-D	
<b>N-type CPU Units with 60 I/O Points</b> 	100 to 240 VAC	36	24	Relay	8K steps	8K words	0.30	0.21	0.13	CP1E-N60DR-A <b><u>NEW</u></b>	CE
				Transistor (sinking)			0.30	0.31	0.02	CP1E-N60DT-A <b><u>NEW</u></b>	
				Transistor (sourcing)			0.30	0.31	0.02	CP1E-N60DT1-A <b><u>NEW</u></b>	
	24 VDC			Relay			--	0.21	0.13	CP1E-N60DR-D <b><u>NEW</u></b>	
				Transistor (sinking)			--	0.31	0.02	CP1E-N60DT-D <b><u>NEW</u></b>	
				Transistor (sourcing)			--	0.31	0.02	CP1E-N60DT1-D <b><u>NEW</u></b>	



Product name	Specifications						External power supply (24 VDC) (A)	Current consumption (A)		Model	Standards
	Power Supply	Inputs	Outputs	Output type	Program capacity	Data memory capacity		5 V	24 V		
<b>NA-type CPU Units with 20 I/O Points (Built-in analog)</b> 	100 to 240 VAC	12 (Built-in analog inputs: 2)	8 (Built-in analog outputs: 1)	Relay	8K steps	8K words	0.30	0.18	0.11	CP1E-NA20DR-A <b>NEW</b>	CE
	24 VDC			Transistor (sinking)			--	0.23	0.09	CP1E-NA20DT-D <b>NEW</b>	
				Transistor (sourcing)			--	0.23	0.09	CP1E-NA20DT1-D <b>NEW</b>	
<b>Battery Set</b> 	For N/NA-type CP1E CPU Units <b>Note:</b> Mount a Battery to an N/NA-type CPU Unit if the data in the following areas must be backed up for power interruptions. • DM Area (D) (except backed up words in the DM Area), Holding Area (H), Counter Completion Flags (C), Counter Present Values (C), Auxiliary Area (A), and Clock Function (Use batteries within two years of manufacture.)									CP1W-BAT01	CE

**Note:** There are no accessories included with N/NA-type CP1E CPU Units. RS-232C connectors for the built-in RS-232C port and the Battery (CP1W-BAT01) are not included.

# CP1E-E□□D□-□ CP1E-N□□D□-□/NA20D□-□

## Options (for CP1E N30/40/60 or NA20 CPU Units)

The Options cannot be used for CP1E N14/20 CPU Units and all E-type CPU Units.

Product name	Specifications	Model	Standards
<b>RS-232C Option Board</b> 	One RS-232C Option Board can be mounted to the Option Board slot. For CP1E N30/40/60 or NA20 CPU Units only. One RS-232C connector is included.	<b>CP1W-CIF01</b>	UC1, N, L, CE
<b>RS-422A/485 Option Board</b> 	One RS-422A/485 Option Board can be mounted to the Option Board slot. For CP1E N30/40/60 or NA20 CPU Units only.	<b>CP1W-CIF11</b>	
<b>RS-422A/485 Isolated-type Option Board</b> 		<b>CP1W-CIF12</b>	N, L, CE

**Note:** It is not possible to use a CP-series Ethernet Option Board (CP1W-CIF41), LCD Option Board (CP1W-DAM01), or Memory Card (CP1W-ME05M) with a CP1E CPU Unit.

## Programming Devices

Product name	Specifications			Model	Standards
		Number of licenses	Media		
<b>FA Integrated Tool Package CX-One Lite Ver.4.□</b>	CX-One Lite is a subset of the complete CX-One package that provides only the Support Software required for micro PLC applications. CX-One Lite runs on the following OS. Windows 2000 (Service Pack 4 or higher), XP, Vista, or 7 (except 64-bit edition) CX-One Lite Ver. 4.□ includes Micro PLC Edition CX-Programmer Ver.9.□.	1 license	CD	<b>CXONE-LT01C-V4</b> <i>NEW</i>	--
<b>CX-One FA Integrated Tool Package Ver. 4.□</b>	CX-One is a comprehensive software package that integrates Support Software for OMRON PLCs and components. CX-One runs on the following OS. OS: Windows 2000 (Service Pack 4 or higher), XP, Vista, or 7 (except 64-bit edition) CX-One Ver. 4.□ includes CX-Programmer Ver. 9.□.	1 license *	CD	<b>CXONE-AL01C-V4</b> <i>NEW</i>	--
			DVD	<b>CXONE-AL01D-V4</b> <i>NEW</i>	

**Note:** The E20, E30, E40, N20, N30 and N40 CPU Units are supported by CX-Programmer version 8.2 or higher.

The E10, E14, N14, N60, and NA20 CPU Units are supported by CX-Programmer version 9.03 or higher.

When Micro PLC Edition CX-Programmer is used, you need version 9.03 or higher.

\* Multi licenses are available for the CX-One (3, 10, 30 or 50 licenses).









The following tables lists the Support Software that can be installed from CX-One

Support Software in CX-One		CX-One Lite Ver.4.□	CX-One Ver.4.□	Support Software in CX-One		CX-One Lite Ver.4.□	CX-One Ver.4.□
Micro PLC Edition CX-Programmer	Ver.9.□	Yes	No	CX-Drive	Ver.1.□	Yes	Yes
CX-Programmer	Ver.9.□	No	Yes	CX-Process Tool	Ver.5.□	No	Yes
CX-Integrator	Ver.2.□	Yes	Yes	Faceplate Auto-Builder for NS	Ver.3.□	No	Yes
Switch Box Utility	Ver.1.□	Yes	Yes	CX-Designer	Ver.3.□	Yes	Yes
CX-Protocol	Ver.1.□	No	Yes	NV-Designer	Ver.1.□	Yes	Yes
CX-Simulator	Ver.1.□	Yes	Yes	CX-Thermo	Ver.4.□	Yes	Yes
CX-Position	Ver.2.□	No	Yes	CX-ConfiguratorFDT	Ver.1.□	Yes	Yes
CX-Motion-NCF	Ver.1.□	No	Yes	CX-FLnet	Ver.1.□	No	Yes
CX-Motion-MCH	Ver.2.□	No	Yes	Network Configurator	Ver.3.□	Yes	Yes
CX-Motion	Ver.2.□	No	Yes	CX-Server	Ver.4.□	Yes	Yes

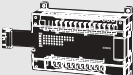
**Note:** For details, refer to the CX-One Catalog (Cat. No. R134).

### Expansion I/O Units and Expansion Units (for CP1E E30/40, N30/40/60, or NA20 CPU Units)

CP1E E10/14/20 or N14/20 CPU Units do not support Expansion I/O Units and Expansion Units.

Unit type	Product name	Specifications			Current consumption (A)		Model	Standards
		Inputs	Outputs	Output type	5 V	24 V		
CP1W Expansion I/O Units	Input Unit 	8	--	--	0.018	--	CP1W-8ED	U, C, N, L, CE
	Output Units 	--	8	Relay	0.026	0.044	CP1W-8ER	
				Transistor (sinking)	0.075	--	CP1W-8ET	
				Transistor (sourcing)	0.075	--	CP1W-8ET1	
		--	16	Relay	0.042	0.090	CP1W-16ER	N, L, CE
				Transistor (sinking)	0.076	--	CP1W-16ET	
				Transistor (sourcing)	0.076	--	CP1W-16ET1	
		--	32	Relay	0.049	0.131	CP1W-32ER	N, L, CE
				Transistor (sinking)	0.113	--	CP1W-32ET	
				Transistor (sourcing)	0.113	--	CP1W-32ET1	
	I/O Units 	12	8	Relay	0.103	0.044	CP1W-20EDR1	U, C, N, L, CE
				Transistor (sinking)	0.130	--	CP1W-20EDT	
Transistor (sourcing)				0.130	--	CP1W-20EDT1		
24		16	Relay	0.080	0.090	CP1W-40EDR	N, L, CE	
			Transistor (sinking)	0.160	--	CP1W-40EDT		
			Transistor (sourcing)	0.160	--	CP1W-40EDT1		
CP1W Expansion Units	Analog Input Unit 	4 analog inputs Input range: 0 to 5 V, 1 to 5 V, 0 to 10 V, ±10 V, 0 to 20 mA, or 4 to 20 mA. Resolution: 1/6000			0.100	0.090	CP1W-AD041	UC1, N, L, CE
	Analog Output Unit 	4 analog outputs Output range: 0 to 5 V, 1 to 5 V, 0 to 10 V, ±10 V, 0 to 20 mA, or 4 to 20 mA. Resolution: 1/6000			0.080	0.124	CP1W-DA041	
	Analog I/O Unit 	2 analog inputs and 1 analog output I/O range: 0 to 5 V, 1 to 5 V, 0 to 10 V, ±10 V, 0 to 20 mA, or 4 to 20 mA. Resolution: 1/6000			0.083	0.110	CP1W-MAD11	U, C, N, L, CE
	Temperature Sensor Unit 	2 temperature sensor inputs Sensor type: Thermocouple (J or K)			0.040	0.059	CP1W-TS001	
		4 temperature sensor inputs Sensor type: Thermocouple (J or K)			0.040	0.059	CP1W-TS002	
		2 temperature sensor inputs Sensor type: Platinum resistance thermometer (Pt100 or JPt100)			0.054	0.073	CP1W-TS101	
		4 temperature sensor inputs Sensor type: Platinum resistance thermometer (Pt100 or JPt100)			0.054	0.073	CP1W-TS102	
CompoBus/S I/O Link Unit 	CompoBus/S slave 8 inputs and 8 outputs			0.029	--	CP1W-SRT21		

### I/O Connecting Cable

Product name	Specifications	Model	Standards
I/O Connecting Cable	80 cm (for CP1W Expansion I/O Units and Expansion Units) Only one I/O Connecting Cable can be used in each PLC.	CP1W-CN811	UC1, N, L, CE

Note: An I/O Connecting Cable (approx. 6 cm) for horizontal connection is provided with CP1W Expansion I/O Units and Expansion Units.

## General Specifications

Type	AC power supply models		DC power supply models
Model	CP1E-□□□□D□-A		CP1E-□□□□D□-D
Enclosure	Mounted in a panel		
Dimensions (H x D x W)	CPU Unit with 10 I/O points (CP1E-E10D□-□): 90mm *1 x85mm *2 x 66 mm CPU Unit with 14 or 20 I/O points (CP1E-□14D□-□/□20D□-□): 90mm *1 x 85mm *2 x 86 mm CPU Unit with 30 I/O points (CP1E-□30D□-□): 90mm *1 x 85mm *2 x 130 mm CPU Unit with 40 I/O points (CP1E-□40D□-□): 90mm *1 x 85mm *2 x 150 mm CPU Unit with 60 I/O points (CP1E-N60D□-□): 90mm *1 x85mm *2 x 195 mm CPU Unit with 20 I/O points and built-in analog (CP1E-NA20D□-□): 90mm *1 x85mm *2 x 130 mm		
Weight	CPU Unit with 10 I/O points (CP1E-E10D□-□): 300g max. CPU Unit with 14 I/O points (CP1E-□14D□-□): 360g max. CPU Unit with 20 I/O points (CP1E-□20D□-□): 370g max. CPU Unit with 30 I/O points (CP1E-□30D□-□): 600g max. CPU Unit with 40 I/O points (CP1E-□40D□-□): 660g max. CPU Unit with 60 I/O points (CP1E-N60D□-□): 850g max. CPU Unit with 20 I/O points and built-in analog (CP1E-NA20D□-□): 680g max.		
Electrical specifications	Supply voltage	100 to 240 VAC 50/60 Hz	24 VDC
	Operating voltage range	85 to 264 VAC	20.4 to 26.4 VDC
	Power consumption	15 VA/100 VAC max. 25 VA/240 VAC max. (CP1E-E10D□-A/□14D□-A/□20D□-A)	9 W max. (CP1E-E10D□-D) 13 W max. (CP1E-N14D□-D/N20D□-D)
		50 VA/100 VAC max. 70 VA/240 VAC max. (CP1E-NA20D□-A/□30D□-A/□40D□-A/N60D□-A)	20 W max. (CP1E-NA20D□-D/N30D□-D/N40D□-D/N60D□-D) *4
	Inrush current	120 VAC, 20 A for 8 ms max. for cold start at room temperature 240 VAC, 40 A for 8 ms max. for cold start at room temperature	24 VDC, 30 A for 20 ms max. for cold start at room temperature
	External power supply *3	Not provided. (CP1E-E10D□-A/□14D□-A/□20D□-A) 24 VDC, 300 mA (CP1E-NA20D□-A/□30D□-A/□40D□-A/N60D□-A)	Not provided
	Insulation resistance	20 MΩ min. (at 500 VDC) between the external AC terminals and GR terminals	Except between DC primary current and DC secondary current
	Dielectric strength	2,300 VAC 50/60Hz for 1 min between AC external and GR terminals Leakage current: 5 mA max.	Except between DC primary current and DC secondary current
Power OFF detection time	10 ms min.	2 ms min.	
Application environment	Ambient operating temperature	0 to 55 °C	
	Ambient humidity	10% to 90%	
	Atmosphere	No corrosive gas.	
	Ambient storage temperature	-20 to 75 °C (excluding battery)	
	Altitude	2,000 m max.	
	Pollution degree	2 or less: Conforms to JIS B3502 and IEC 61131-2.	
	Noise resistance	2 kV on power supply line (Conforms to IEC61000-4-4.)	
	Overvoltage category	Category II: Conforms to JIS B3502 and IEC 61131-2.	
	EMC Immunity Level	Zone B	
	Vibration resistance	Conforms to JIS 60068-2-6. 5 to 8.4 Hz with 3.5-mm amplitude, 8.4 to 150 Hz Acceleration of 9.8 m/s <sup>2</sup> for 100 min in X, Y, and Z directions (10 sweeps of 10 min each = 100 min total)	
Shock resistance	Conforms to JIS 60068-2-27. 147 m/s <sup>2</sup> , 3 times in X, Y, and Z directions		
Terminal block	Fixed (not removable)		
Terminal screw size	M3		
Applicable standards	Conforms to EC Directive		
Grounding method	Ground to 100 Ω or less.		

\* 1 Total of 110 mm with mounting brackets.

\* 2 Excluding cables.

\* 3 Use the external power supply to power input devices. Do not use it to drive output devices.

\* 4 This is the rated value for the maximum system configuration. Use the following formula to calculate power consumption for CPU Units with DC power.

Formula: DC power consumption = (5V current consumption × 5 V/70% (internal power efficiency) + 24V current consumption) × 1.1 (current fluctuation factor)

The above calculation results show that a DC power supply with a greater capacity is required.



# Performance Specifications

Item		CP1E-□□□□□□	CP1E-N□□□□□□ CP1E-NA□□□□□□	
<b>Program capacity</b>		2 K steps (8 Kbytes) including the symbol table, comments, and program indices of the CX-Programmer	8 K steps (32 Kbytes) including the symbol table, comments, and program indices of the CX-Programmer	
<b>Control method</b>		Stored program method		
<b>I/O control method</b>		Cyclic scan with immediate refreshing		
<b>Program language</b>		Ladder diagram		
<b>Instructions</b>		Approximately 200		
<b>Processing speed</b>	<b>Overhead processing time</b>	0.4 ms		
	<b>Instruction execution times</b>	Basic instructions (LD): 1.19 μs min. Special instructions (MOV): 7.9 μs min.		
<b>Number of CP1W-series Expansion Units connected</b>		CP1E-E10D□-□/□14D□-□/□20D□-□: None CP1E-□30D□-□/□40D□-□/□60D□-□/□NA20D□-□: 3 units		
<b>Maximum number of I/O points</b>		CP1E-E10D□-□ : 10 CP1E-□14D□-□ : 14 CP1E-□20D□-□ : 20 CP1E-□30D□-□ : 150 (30 built in, 40 × 3 expansion) CP1E-□40D□-□ : 160 (40 built in, 40 × 3 expansion) CP1E-N60D□-□ : 180 (60 built in, 40 × 3 expansion) CP1E-NA20D□-□: 140 (20 built in, 40 × 3 expansion)		
<b>Built-in I/O</b>		CP1E-E10D□-□ : 10 (6 inputs, 4 outputs) CP1E-□14D□-□ : 14 (8 inputs, 6 outputs) CP1E-□20D□-□ : 20 (12 inputs, 8 outputs) CP1E-□30D□-□ : 30 (18 inputs, 12 outputs) CP1E-□40D□-□ : 40 (24 inputs, 16 outputs) CP1E-N60D□-□ : 60 (36 inputs, 24 outputs) CP1E-NA20D□-□: 20 (12 inputs, 8 outputs)		
<b>Built-in input functions</b>	<b>High-speed counters</b>	<b>High-speed counter mode/ maximum frequency</b>	Incremental Pulse Inputs 10 kHz: 6 counters 5 counters (only for 10 I/O points) Up/Down Inputs 10 kHz: 2 counters Pulse + Direction Inputs 10 kHz: 2 counters Differential Phase Inputs (4x) 5 kHz: 2 counters	Incremental Pulse Inputs 100 kHz: 2 counters, 10 kHz: 4 counters Up/Down Inputs 100 kHz: 1 counters, 10 kHz: 1 counters Pulse + Direction Inputs 100 kHz: 2 counters Differential Phase Inputs (4x) 50 kHz: 1 counter, 5 kHz: 1 counter
		<b>Counting mode</b>	Linear mode Ring mode	
		<b>Count value</b>	32 bits	
		<b>Counter reset modes</b>	Phase Z and software reset (excluding increment pulse input) Software reset	
		<b>Control method</b>	Target Matching Range Comparison	
	<b>Input interrupts</b>		6 inputs (4 inputs only for 10 I/O points) Interrupt input pulse width: 50 μs min.	
	<b>Quick-response Inputs</b>		6 inputs (4 inputs only for 10 I/O points) Input pulse width: 50 μs min.	
	<b>Normal input</b>	<b>Input constants</b>	Delays can be set in the PLC Setup (0 to 32 ms, default: 8 ms). Set values: 0, 1, 2, 4, 8, 16, or 32 ms	
<b>Built-in output functions</b>	<b>Pulse outputs (Models with transistor outputs only)</b>	<b>Pulse output method and output frequency</b>		Pulse + Direction Mode 1 Hz to 100 kHz: 2 outputs
		<b>Output mode</b>		Continuous mode (for speed control) Independent mode (for position control)
		<b>Number of output pulses</b>	Pulse output function not included	Relative coordinates: 0000 0000 to 7FFF FFFF hex (0 to 2147483647) Absolute coordinates: 8000 0000 to 7FFF FFFF hex (-2147483647 to 2147483647)
		<b>Acceleration/deceleration curves</b>		Trapezoidal acceleration and deceleration (Cannot perform S-curve acceleration and deceleration.)
		<b>Changing SVs during instruction execution</b>		Only target position can be changed.
		<b>Origin searches</b>		Included
	<b>Pulse outputs (Models with transistor outputs only)</b>	<b>Frequency</b>		2.0 to 6,553.5 Hz (in increments of 0.1 Hz) with 1 output or 2 Hz to 32,000 Hz (in increments of 1 Hz) with 1 output
		<b>Duty factor</b>	PWM output function not included	0.0% to 100.0% (in increments of 0.1%) Accuracy: +1%/-0% at 2 Hz to 10,000 Hz and +5%/-0% at 10,000 Hz to 32,000 kHz
		<b>Output mode</b>		Continuous Mode
	<b>Built-in analog</b>		<b>Analog input</b>	Analog function not included
<b>Analog output</b>			Setting range: 0 to 6,000 (2 channels only for NA-type) Setting range: 0 to 6,000 (1 channels only for NA-type)	
<b>Analog adjusters</b>		2 adjusters (Setting range: 0 to 255)		

# CP1E-E□□D□-□ CP1E-N□□D□-□/NA20D□-□

Item		CP1E-E□□D□-□	CP1E-N□□D□-□ CP1E-NA□□D□-□		
Communications	B-type Peripheral USB Port	Conforming to USB 2.0 B type connector			
		Transmission distance	5 m max.		
	Built-in RS-232C port	No built-in RS-232C port		Interface: Conforms to EIA RS-232C.	
				Communications method	Half duplex
				synchronization	Start-stop
				Baud rate	1.2, 2.4, 4.8, 9.6, 19.2, 38.4, 57.6, or 115.2 kbps
				Transmission distance	15 m max.
	Supported protocol	<ul style="list-style-type: none"> <li>• Host Link</li> <li>• 1:N NT Link</li> <li>• No-protocol mode</li> <li>• Serial PLC Links (master, slave)</li> <li>• Modbus-RTU Easy Master</li> </ul>			
	Serial Option port	Option Board cannot be mounted.		1 port (Option Board can be mounted only to N30/40/60 and NA20 CPU Units.)	
				Mountable Option Boards	<ul style="list-style-type: none"> <li>• One RS-232C port: CP1W-CIF01</li> <li>• One RS-422A/485 port (not isolated): CP1W-CIF11</li> <li>• One RS-422A/485 port (isolated): CP1W-CIF12</li> </ul>
Communications method				Depends on Option Board.	
synchronization				Depends on Option Board.	
Baud rate				1.2, 2.4, 4.8, 9.6, 19.2, 38.4, 57.6, or 115.2 kbps	
Compatible protocols	<ul style="list-style-type: none"> <li>• Host Link</li> <li>• 1:N NT Link</li> <li>• No-protocol mode</li> <li>• Serial PLC Links (master, slave)</li> <li>• Modbus-RTU Easy Master</li> </ul>				
Number of tasks	17 <ul style="list-style-type: none"> <li>• One cyclic execution task</li> <li>• One scheduled interrupt task (always interrupt task 1)</li> <li>• Six input interrupt tasks (interrupt tasks 2 to 7)</li> <li>• Sixteen high-speed counter interrupt tasks (interrupt tasks 1 to 16)</li> </ul>				
Maximum subroutine number	128				
Maximum jump number	128				
Scheduled interrupt tasks	1 interrupt task				
Clock	Clock function not included. The time of error occurrence displays 01-01-01 01:01:01 Sunday		Included. Accuracy (monthly deviation): -4.5 min to -0.5 min at ambient temperature of 55°C, -2.0 min to +2.0 min at ambient temperature of 25°C, -2.5 min to +1.5 min at ambient temperature of 0°C		
	Built-in EEPROM	Ladder programs and parameters are automatically saved to built-in EEPROM A section of the Data Memory Area can be saved to the built-in EEPROM.			
Memory backup	Battery backup With CP1W-BAT01 Battery (Sold separately)	Battery cannot be mounted.  CP1W-BAT01 can be used. Maximum battery service life: 5 years Backup Time Guaranteed value (ambient temperature: 55°C): 13,000 hours (approx. 1.5 years) Effective value (ambient temperature: 25°C): 43,000 hours (approx. 5 years)			
	Input Bits	1,600 bits (100 words): CIO 0.00 to CIO 99.15 (CIO 00 to CIO 99)			
CIO Area	Output Bits	1,600 bits (100 words): CIO 100.00 to CIO 199.15 (CIO 100 to CIO 199)			
	Serial PLC Link Words	1,440 bits (90 words): CIO 200.00 to CIO 289.15 (words CIO 200 to CIO 289)			
Work Area (W)	1,600 bits (100 words): W0.00 to W99.15 (W0 to W99)				
Holding Area (H)	800 bits (50 words): H0.00 to H49.15 (H0 to H49) Bits in this area maintain their ON/OFF status when operating mode is changed.				
Auxiliary Area (A)	Read-only: 7,168 bits (448 words) A0 to A447 Read/write: 4,896 bits (306 words) in words A448 to A753				
Temporary Relay Area (TR) (TR Area)	16 bits: TR0 to TR15				
Timer Area (T)	256 timer numbers (T0 to T255 (separate from counters))				
Counter Area (C)	256 counter numbers (C0 to C255 (separate from timers))				
Data Memory Area (D)	2 Kwords: D0 to D2047 Of these, 1,500 words can be saved to the backup memory (built-in EEPROM) using settings in the Auxiliary Area.		8 Kwords: D0 to D8191 Of these, 7,000 words can be saved to the backup memory (built-in EEPROM) using settings in the Auxiliary Area		
Operating modes	PROGRAM mode: Program execution is stopped. Preparations can be executed prior to program execution in this mode. MONITOR mode: Programs are executed. Some operations, such as online editing, and changes to present values in I/O memory, are enabled in this mode. RUN mode: Programs are executed. This is the normal operating mode.				

# Function Specifications

Function		Function description			
Cycle time management	Minimum cycle time		Makes the cycle time consistent.		
	Monitoring the cycle time		Monitors the cycle time.		
CPU Unit built-in functions	Inputs	High-speed counter inputs	High-speed pulse inputs	High-speed pulses from devices such as a rotary encoder are counted. The counted values are stored in the Auxiliary Area. Interrupt tasks can be executed when target is reached or by range comparison.	
			Input pulse frequency measurement	The frequency of pulses input by the PRV instruction is measured.	
		Interrupt inputs		Relevant interrupt tasks are executed during the cycle when the CPU Unit built-in inputs turn ON or turn OFF.	
		Quick-response inputs		Inputs can be read without being affected by cycle time. Use the quick-response inputs to read signals shorter than the cycle time.	
		Normal inputs	I/O refreshing	Cyclic refreshing	The CPU Unit's built-in I/O are cyclically refreshed.
				Immediate refreshing	I/O refreshing by immediate refreshing instructions
	Input response times		Input constants can be set for Basic I/O Units. The response time can be increased to reduce the effects of chattering and noise at input contacts. The response time can be decreased to enable detecting shorter input pulses.		
	Outputs	Pulse outputs (Models with transistor outputs only)	Pulse control		A pulse signal is output and positioning or speed control is performed with a servo driver that accepts a pulse input. Continuous mode for speed control or independent mode for position control can be used. There are functions for changing to positioning during speed control and for changing the target value during positioning.
			Origin positioning		Origin searches and origin returns
		PWM outputs (Models with transistor outputs only)		Pulses for which the duty ratio (ratio between ON time and OFF time during one pulse cycle) can be set are output.	
		Normal outputs	Load OFF function		All of the outputs on the CPU Unit's I/O can be turned OFF when an error occurs in RUN or MONITOR mode.
	Built-in analog	Analog input		Convert analog signal into digital value range from 0 to 6,000.	
		Analog output		Convert digital value range from 0 to 6,000 into analog signal.	
Expansion I/O Units and Expansion Units	Functions supported by both Expansion I/O Unit and Expansion Unit	I/O refreshing	Cyclic refreshing	The Expansion I/O Units and Expansion Units are cyclically refreshed.	
			Refreshing by IORF	I/O refreshing by IORF instruction	
	Load OFF function		All of the outputs on Expansion I/O Units and Expansion Units are turned OFF (0000 hex) when an error occurs in RUN or MONITOR mode.		
	Expansion I/O Units	Input response times		The response time can be increased to reduce the effects of chattering and noise at input contacts. The response time can be decreased to enable detecting shorter input pulses.	
Expansion Units	Unit error detection		Errors in Expansion Units are detected. The CPU Unit is notified that the Expansion Unit stopped due to an error.		
Memory management functions	Holding I/O memory when changing operating modes		The status of I/O memory can be held when the operating mode is changed. The forced-set/reset status can be held when the operating mode is changed.		
	Automatic backup to the backup memory (built-in EEPROM)		Automatic backup of ladder programs and parameter area to the backup memory (built-in EEPROM)		
Communications	Peripheral USB port	Peripheral bus (toolbus)		For communications with programming device (CX-Programmer).	
	Serial port (N/NA-type only)		--		
	Host Link (SYSWAY) communications		Host Link commands can be sent from a PT or a computer to read/write I/O memory, and perform other operations for PLC.		
	No-protocol communications		I/O instructions for communications ports (TXD/RXD instructions) can be used for data transfer with peripheral devices such as bar code readers.		
	NT Link communications		I/O memory in the PLC can be allocated and directly linked to various PT functions, including status control areas, status notification areas, touch switches, lamps, memory tables, and other objects.		
	Serial PLC Links		Up to ten words per Unit can be shared by up to nine CPU Units, including one Polling Unit and eight Polled Units. <b>Note:</b> Programmable Terminal (PT) cannot be connected.		
Modbus-RTU Easy Master function		Modbus-RTU commands are sent by the Modbus-RTU Master function. Modbus slaves, such as inverters, can be easily controlled with serial communications.			
Interrupt	Scheduled interrupts		Tasks can be executed at a specified interval (1.0 ms min., Unit: 0.1 ms).		
	Interrupt inputs		Interrupt tasks are processed when the built-in input turns ON or OFF.		
	High-speed counter interrupts		This function counts input pulses with the CPU Unit's built-in high-speed counter and executes an interrupt task when the count reaches the preset value or falls within a preset range (target value or zone comparison).		

Function		Function description	
Power supply management	Memory protection	Holding Area data, DM Area data, Counter Completion Flags, and counter present values are held even when power is turned OFF. This function can be used only with an N/NA-type CPU Unit and only when the Battery Set (sold separately) is mounted.	
	Number of power interruptions counter	The number of times power has been interrupted is counted.	
Debugging	Online editing	The program can be changed during operation in MONITOR mode or PROGRAM mode.	
	Force-set/reset	Specified bits can be set or reset.	
	Differentiate monitoring	ON/OFF changes in specified bits can be monitored.	
	Storing the stop position at errors	The location and task number where execution stopped for a program error is recorded.	
	Program check	The programs can be checked for items such as no END instruction and FALS/FAL errors at startup.	
Self-diagnosis and restoration	Error Log	Details and the time of occurrence of error codes predefined by the CPU Unit are stored.	
	CPU error detection	CPU Unit WDT errors are detected.	
	User-defined failure diagnosis	Errors can be generated for user-specified conditions: Non-fatal errors (FAL) and fatal errors (FALS).	
	Load OFF function	The built-in outputs, Expansion I/O Unit outputs, and Expansion Unit outputs are turned OFF.	
	Non-fatal error detection	System FAL error detection (User-defined non-fatal error)	This function generates a non-fatal (FAL) error when the user-defined conditions are met in program.
		Backup memory error detection	This function detects when data in the backup memory (built-in EEPROM) that stores the ladder program is corrupted.
		PLC Setup error detection	This function detects setting errors in the PLC Setup.
		Option Board errors	This function detects when the Option Board is malfunctioning or disconnected.
		Battery error detection (N/NA-type CPU Units only)	This function detects when the battery voltage is low or the battery is disconnected. <b>Note:</b> This function is valid only when a battery is mounted and the <b>Do not detect battery error</b> Check Box is cleared in the PLC Setup.
		Built-in analog error	This function detects when a built-in analog I/O error occurs and stops the operation of built-in analog I/O.
	Fatal Error Detection	Memory error detection	This function detects errors that occur in memory of the CPU Unit.
		I/O bus error detection	This function detects errors that occur during data transfer between the CPU Unit and another Unit.
		Too Many I/O Points Error Detection	This function detects when more than the maximum number of CP1W Expansion I/O Units and Expansion Units are connected to the PLC.
		Program error detection	This function detects when there is an error in the program. See the following for details.
		Instruction processing error detection	This function detects an error when the given data value is invalid when executing an instruction, or execution of instruction between tasks was attempted.
		Indirect DM addressing BCD error	This function detects an error when an indirect DM address in BCD mode is not BCD.
		Illegal area access error detection	This function detects an error when an attempt is made to access an illegal area with an instruction operand.
		No END error detection	This function detects an error when there is no END instruction at the end of the program.
		Task error detection	The execution condition for an interrupt task was met but there is no interrupt task with the specified number.
		overflow error detection	This function detects an error when too many differentiated instructions are entered or deleted during online editing (131,072 times or more).
Invalid instruction error detection		This function detects an error when an attempt is made to execute an instruction that is not defined in the system.	
User program area overflow error detection		This function detects an error when instruction data is stored after the last address in user program area.	
Cycle time exceeded error detection		This function monitors the cycle time (10 to 1,000 ms) and stops the operation when the set value is exceeded.	
System FALS error detection (user-defined fatal error)		This function generates a fatal (FALS) error when the user-defined conditions are met in program.	
Maintenance	Automatic online connection via network	This function enables automatically connecting to the PLC online when the CX-Programmer is directly connected by a serial connection (peripheral USB port or serial port).	
Security functions	Read protection using password	This function protects user memory. Read protection: Set a password using the CX-Programmer. Overwrite protection is not provided.	
	Write protection from FINS commands	This function prohibits writing by using FINS commands sent over the network.	

## Internal Memory in the CPU Units

### CPU Unit Memory Backup Structure

The internal memory in the CPU Unit consists of built-in RAM and built-in EEPROM. The built-in RAM is used as execution memory and the built-in EEPROM is used as backup memory.

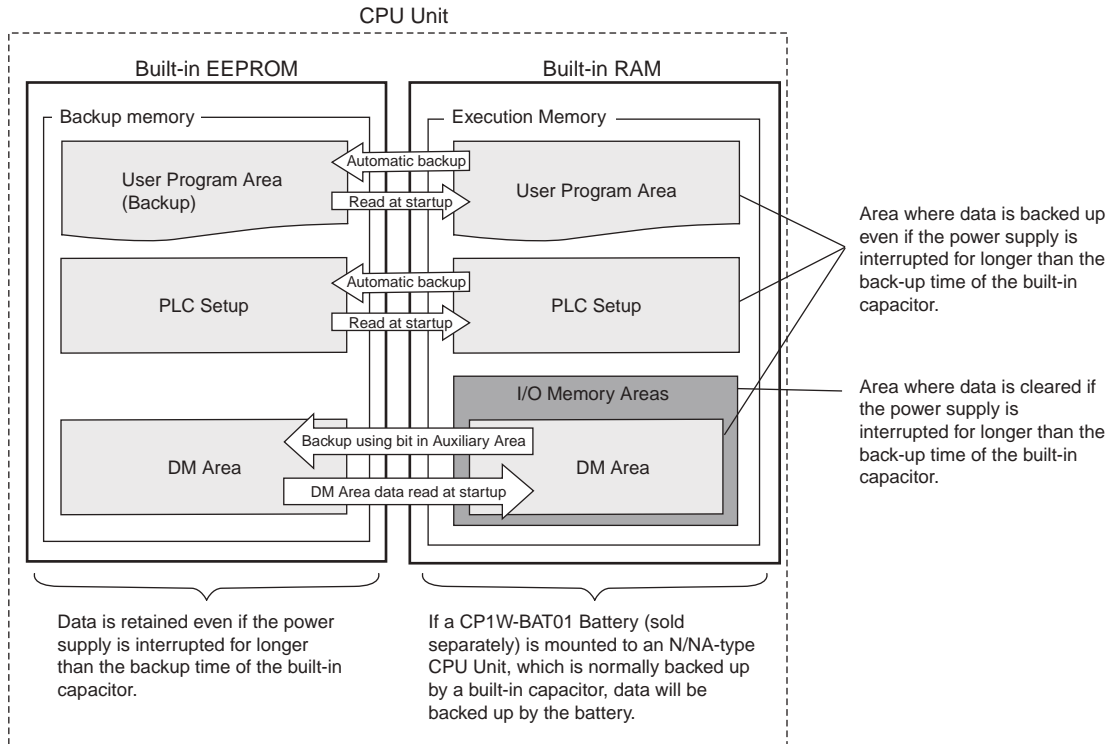

### ●Precautions for Correct Use

Create a system and write the ladder programs so that problems will not occur in the system if the data in these areas may be unstable.

- Data in areas such as the DM area (D), Holding Area (H), the Counter Present Values (C) and the status of Counter Completion Flags (C), which is retained by the battery, may be unstable when the power supply is turned off (Except for the DM area that are retained by the built-in EEPROM using the Auxiliary Area bit.)
- The error log, and clock data (N/NA-type CPU Unit only) in the Auxiliary Area will become unstable. Other words and bits in the Auxiliary Area will be cleared to their default values.

The built-in capacitor's backup time varies with the ambient temperature as shown in the following graph.

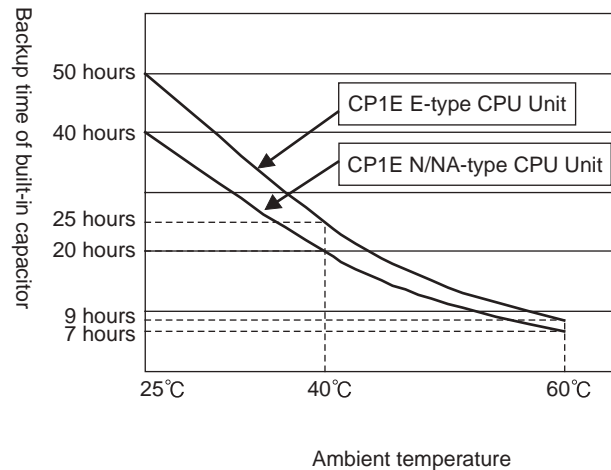

## I/O Memory Areas

Data can be read and written to I/O memory from the ladder programs. I/O memory consists of an area for I/O with external devices, user areas, and system areas.

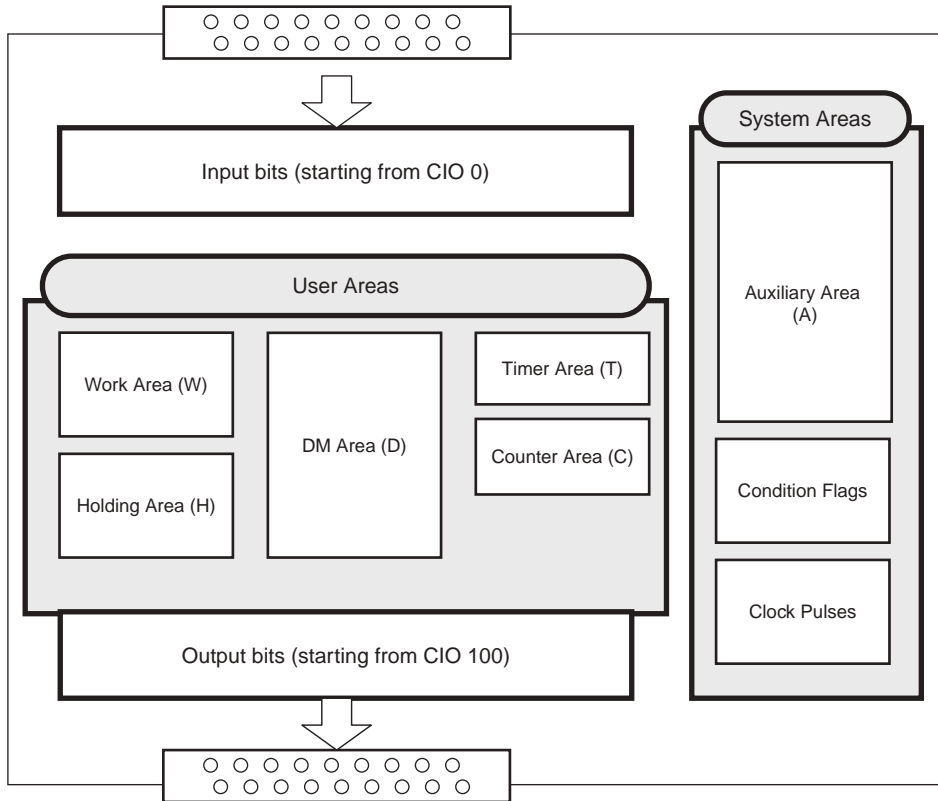

## I/O Memory Areas

Name		No. of bits	Word addresses	Remarks
CIO Area	Input Bits	1,600 bits (100 words)	CIO 0 to CIO 99	For NA-type, CIO90, CIO91 is occupied by analog input 0, 1.
	Output Bits	1,600 bits (100 words)	CIO 100 to CIO 199	For NA-type, CIO190 is occupied by analog output 0.
	Serial PLC Link Words	1,440 bits (90 words)	CIO 200 to CIO 289	--
Work Area (W)		1,600 bits (100 words)	W0 to W99	--
Holding Area (H)		800 bits (50 words)	H0 to H49	Data in this area is retained during power interruptions if a Battery Set (sold separately) is mounted to an N/NA-type CPU Unit.
Data Memory Area (D)	E-type CPU Unit	2K words	D0 to D2047	Data in specified words of the DM Area can be retained in the built-in EEPROM in the backup memory by using a bit in the Auxiliary Area. Applicable words: D0 to D1499 (One word can be specified at a time.)
	N/NA-type CPU Unit	8K words	D0 to D8191	Data in specified words of the DM Area can be retained in the built-in EEPROM in the backup memory by using a bit in the Auxiliary Area. Applicable words: D0 to D6999 (One word can be specified at a time.)
Timer Area (T)	Present values	256	T0 to T255	--
	Timer Completion Flags	256		--
Counter Area (C)	Present values	256	C0 to C255	Data in this area is retained during power interruptions if a Battery Set (sold separately) is mounted to an N/NA-type CPU Unit.
	Counter Completion Flags	256		--
Auxiliary Area (A)	Read only	7168 bits (448 words)	A0 to A447	Data in this area is retained during power interruptions if a Battery Set (sold separately) is mounted to an N/NA-type CPU Unit.
	Read-write	4,896 bits (306 words)	A448 to A753	

## Backing Up and Restoring DM Area Data

The contents of the DM Area (D) will become unstable if the power supply is interrupted for longer than the backup time of the built-in capacitor (50 hours for an E-type CPU Unit, 40 hours for an N/NA-type CPU Unit without a Battery).

The contents of the specified words in the DM Area data can be backed up from RAM to the built-in EEPROM backup memory during operation by turning ON a bit in the Auxiliary Area. The number of DM Area words to back up is specified in the Number of CH of DM for backup Box in the PLC Setup. If the Restore D0- from backup memory Check Box is selected in the PLC Setup, the backup data will automatically be restored to RAM when the power is turned back ON so that data is not lost even if power is interrupted.

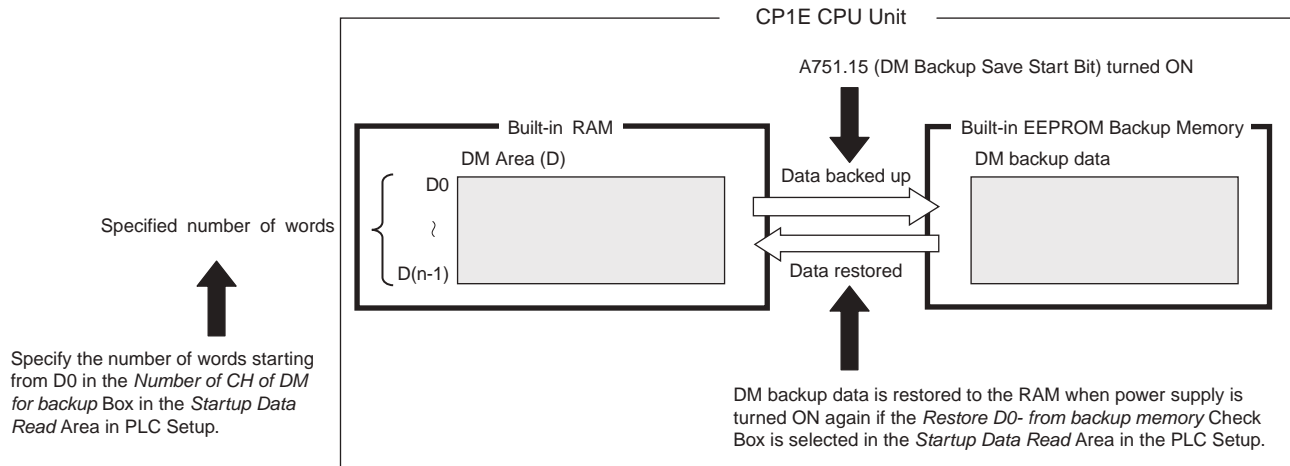

### Conditions for Executing Backup

Specified words starting from D0 in the RAM can be saved to the built-in EEPROM backup memory by turning ON A751.15. (These words are called the DM backup words and the data is called the DM backup data.)

A751.15 (DM Backup Save Start Bit) can be used in any operating mode (RUN, MONITOR, or PROGRAM mode).

### Words That Can Be Backed Up

- E-type CP1E CPU Units: D0 to D1499
- N/NA-type CP1E CPU Units: D0 to D6999

### Number of Words To Back Up

The number of words to back up starting from D0 is set in the *Number of CH of DM for backup* Box in the *Startup Data Read Area* in the PLC Setup.

### Restoring DM Backup Data to RAM When Power Is Turned ON

The DM backup data can be restored to RAM when power is turned ON by selecting the *Restore D0- from backup memory* Check Box in the *Startup Data Read Area* in the PLC Setup.

The DM backup data will be read from the backup memory even if the *Clear retained memory area (HR/DM/CNT)* Check Box is selected in the PLC Setup.

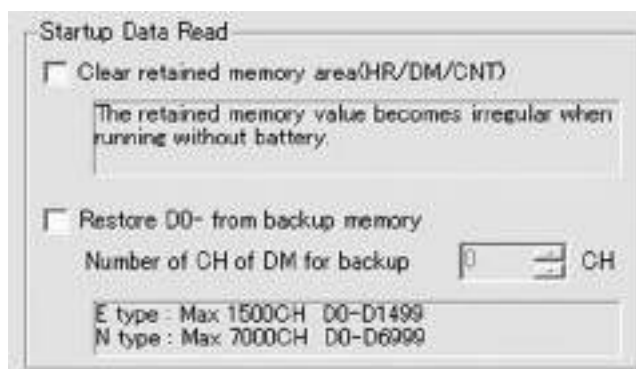

## Built-in Inputs

### Terminal Arrangements

#### ●Input Terminal Arrangement for CPU Unit with 10 I/O Points

AC power supply models

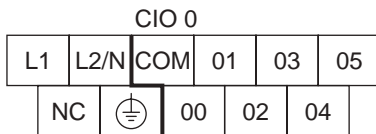

DC power supply models

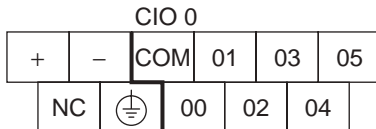

#### ●Input Terminal Arrangement for CPU Unit with 14 I/O Points

AC power supply models

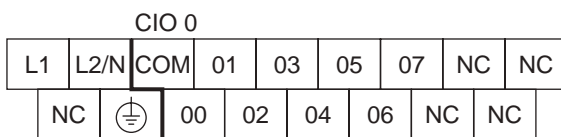

DC power supply models

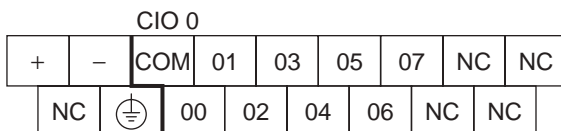

#### ●Input Terminal Arrangement for CPU Unit with 20 I/O Points

AC power supply models

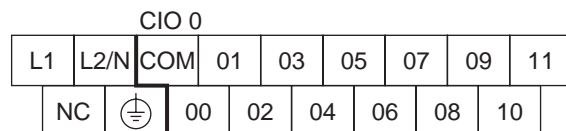

DC power supply models

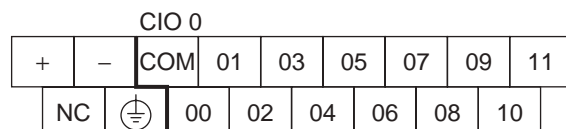

#### ●Input Terminal Arrangement for CPU Unit with 30 I/O Points

AC power supply models

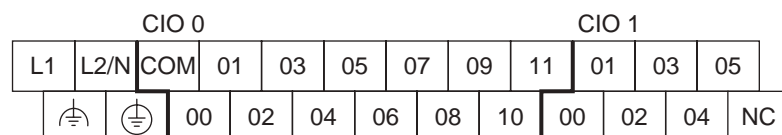

DC power supply models

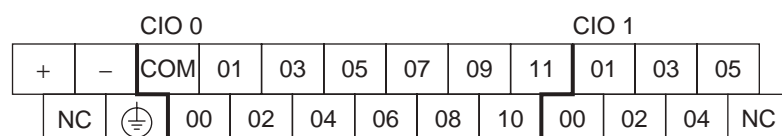



●Input Terminal Arrangement for CPU Unit with 40 I/O Points

AC power supply models

CIO 0											CIO 1				
L1	L2/N	COM	01	03	05	07	09	11	01	03	05	07	09	11	
			00	02	04	06	08	10	00	02	04	06	08	10	

DC power supply models

CIO 0											CIO 1				
+	-	COM	01	03	05	07	09	11	01	03	05	07	09	11	
NC			00	02	04	06	08	10	00	02	04	06	08	10	

●Input Terminal Arrangement for CPU Unit with 60 I/O Points

AC power supply models

CIO 0											CIO 1					CIO 2				
L1	L2/N	COM	01	03	05	07	09	11	01	03	05	07	09	11	01	03	05	07	09	11
			00	02	04	06	08	10	00	02	04	06	08	10	00	02	04	06	08	10

DC power supply models

CIO 0											CIO 1					CIO 2				
+	-	COM	01	03	05	07	09	11	01	03	05	07	09	11	01	03	05	07	09	11
NC			00	02	04	06	08	10	00	02	04	06	08	10	00	02	04	06	08	10

●Input Terminal Arrangement for CPU Unit with 20 I/O Points and Built-in Analog

AC power supply models

CIO 0											CIO 90		CIO 91	
L1	L2/N	COM	01	03	05	07	09	11	I IN0	AG	I IN1			
			00	02	04	06	08	10	VIN0	COM0	VIN1	COM1		

DC power supply models

CIO 0											CIO 90		CIO 91	
+	-	COM	01	03	05	07	09	11	I IN0	AG	I IN1			
NC			00	02	04	06	08	10	VIN0	COM0	VIN1	COM1		

## Allocating Built-in Inputs to Functions

Input terminals are allocated functions by setting parameters in the PLC Setup. Set the PLC Setup so that each terminal is used for only one function.

CPU Unit with I/O Points	Input terminal block		Settings in PLC Setup							
			Interrupt input setting on Built-in Input Tab Page			High-speed counter 0 to 3 setting on Built-in Input Tab Page			Origin search settings on Pulse Output 0/1 Tab Page	
	Terminal block label	Terminal number	Normal input	Interrupt input	Quick-response input	Single-phase (increment pulse input)	Two-phase (differential phase x4 or up/down)	Two-phase (pulse/direction)	CPU Unit with 20 to 60 points	CPU Unit with 14 I/O points
10	CIO 0	00	Normal input 0	--	--	Counter 0, increment input	Counter 0, phase A or up input	Counter 0, pulse input	--	--
		01	Normal input 1	--	--	Counter 1, increment input	Counter 0, phase B or down input	Counter 1, pulse input	--	--
		02	Normal input 2	Interrupt input 2	Quick-response input 2	Counter 2, increment input	Counter 1, phase A or up input	Counter 0, direction	--	--
		03	Normal input 3	Interrupt input 3	Quick-response input 3	--	Counter 1, phase B or down input	Counter 1, direction	--	Pulse 0, Origin proximity input signal
		04	Normal input 4	Interrupt input 4	Quick-response input 4	Counter 3, increment input	Counter 0, phase Z or reset input	Counter 0, reset input	--	--
		05	Normal input 5	Interrupt input 5	Quick-response input 5	Counter 4, increment input	Counter 1, phase Z or reset input	Counter 1, reset input	--	Pulse 1, Origin proximity input signal
		06	Normal input 6	Interrupt input 6	Quick-response input 6	Counter 5, increment input	--	--	Pulse 0: Origin input signal	Pulse 0, Origin proximity input signal
		07	Normal input 7	Interrupt input 7	Quick-response input 7	--	--	--	Pulse 1: Origin input signal	Pulse 1, Origin proximity input signal
		08	Normal input 8	--	--	--	--	--	--	--
		09	Normal input 9	--	--	--	--	--	--	--
		10	Normal input 10	--	--	--	--	--	Pulse 0: Origin proximity input signal	--
14	CIO 0	11	Normal input 11	--	--	--	--	--	Pulse 1: Origin proximity input signal	--
		00 to 05	Normal input 12 to 17	--	--	--	--	--	--	--
30	CIO 1	06 to 11	Normal input 18 to 23	--	--	--	--	--	--	--
		00 to 11	Normal input 24 to 35	--	--	--	--	--	--	--
40	CIO 2	00 to 11	Normal input 24 to 35	--	--	--	--	--	--	--

These functions are supported only by N/NA-type CPU Units with transistor outputs.

## Built-in Outputs

### Terminal Arrangements

#### ●Output Terminal Arrangement for CPU Unit with 10 I/O Points

AC power supply model  
DC power supply model

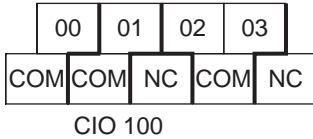

#### ●Output Terminal Arrangement for CPU Unit with 14 I/O Points

AC power supply model  
DC power supply model

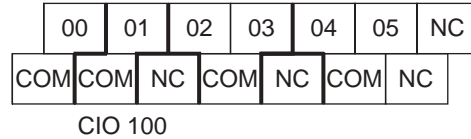

#### ●Output Terminal Arrangement for CPU Unit with 20 I/O Points

AC power supply model  
DC power supply model

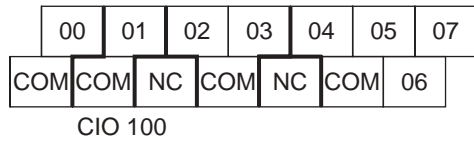

#### ●Output Terminal Arrangement for CPU Unit with 30 I/O Points

AC power supply model

DC power supply model

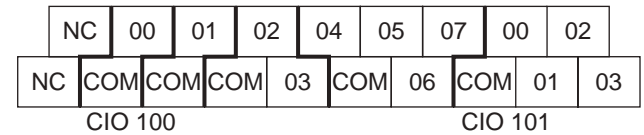
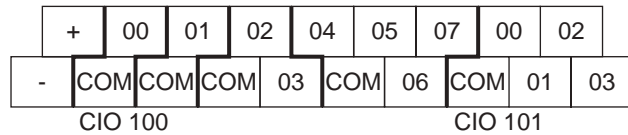

#### ●Output Terminal Arrangement for CPU Unit with 40 I/O Points

AC power supply model

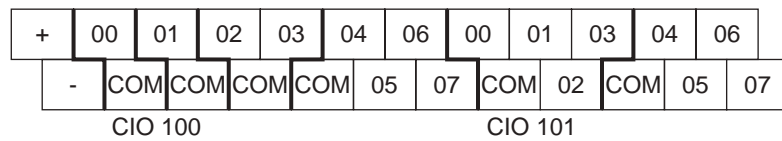

DC power supply model

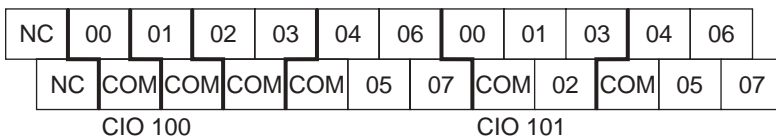

#### ●Output Terminal Arrangement for CPU Unit with 60 I/O Points

AC power supply model

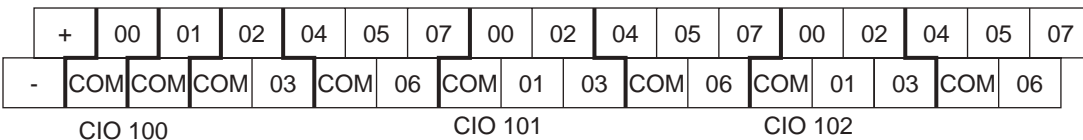

DC power supply model

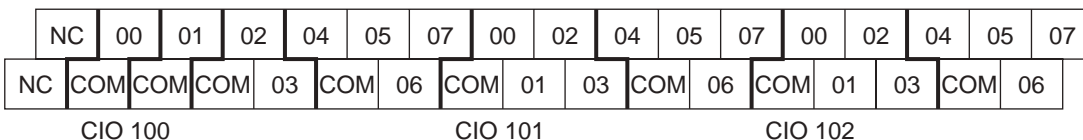

#### ●Output Terminal Arrangement for CPU Unit with 20 I/O Points and Built-in Analog

AC power supply model

DC power supply model

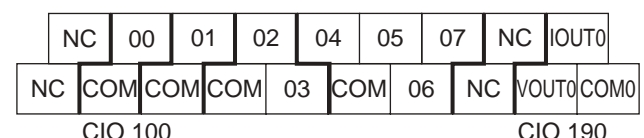
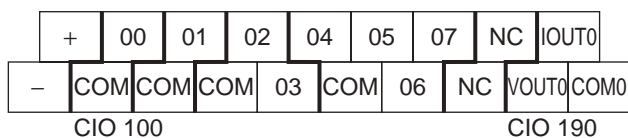

## Allocating Built-in Output Terminals to Functions

Output terminals are allocated functions by setting parameters in the PLC Setup. Set the PLC Setup so that each terminal is used for only one function.

CPU Unit with I/O points	Output terminal block		Other than those shown right	When a pulse output instruction (SPED, ACC, PLS2, or ORG) is executed	Setting in PLC Setup Origin search setting on Pulse Output 0/1 Tab Page	When the PWM instruction is executed
	Terminal block label	Terminal number	Normal output	Fixed duty ratio pulse output		Variable duty ratio pulse output
				Pulse + direction	Use	PWM output
10	CIO 100	00	Normal output 0	Pulse output 0 (pulse)	--	--
		01	Normal output 1	Pulse output 1 (pulse)	--	PWM output 0
		02	Normal output 2	Pulse output 0 (direction)	--	--
		03	Normal output 3	Pulse output 1 (direction)	--	--
		04	Normal output 4	--	Pulse 0: Error counter reset output	--
		05	Normal output 5	--	Pulse 1: Error counter reset output	--
		06	Normal output 6	--	--	--
		07	Normal output 7	--	--	--
30	CIO 101	00 to 03	Normal output 8 to 11	--	--	--
40		04 to 07	Normal output 12 to 15	--	--	--
60	CIO 102	00 to 07	Normal output 16 to 23	--	--	--

These functions are supported only by N/NA-type CPU Units with transistor outputs.

# I/O Specifications for CPU Units

## Input Specifications

Item	Specification		
Input type	High-speed counter inputs or Normal Inputs	High-speed counter inputs, interrupt input, quick-response inputs, or Normal Inputs	Normal inputs
Input bits	CIO 0.00 to CIO 0.01	CIO 0.02 to CIO 0.07 *1	CIO 0.08 to CIO 0.11, CIO 1.00 to CIO 1.11 and CIO 2.00 to CIO 2.11 *1
Input voltage	24 VDC, +10%, -15%		
Applicable sensors	2-wire and 3-wire sensors		
Input Impedance	3.3 kΩ	3.3 kΩ	4.8 kΩ
Input current	7.5 mA typical	7.5 mA typical	5 mA typical
ON voltage/current	3 mA min. at 17.0 VDC min.	3 mA min. at 17.0 VDC min.	3 mA min. at 14.4 VDC min.
OFF voltage/current	1 mA max. at 5.0 VDC max.	1 mA max. at 5.0 VDC max.	1 mA max. at 5.0 VDC max.
ON response time *2	E-type CPU Unit: 50 μs min. N/NA-type CPU Unit: 2.5 μs min.	50 μs max.	1 ms max.
OFF response time *2	E-type CPU Unit: 50 μs min. N/NA-type CPU Unit: 2.5 μs min.	50 μs max.	1 ms max.

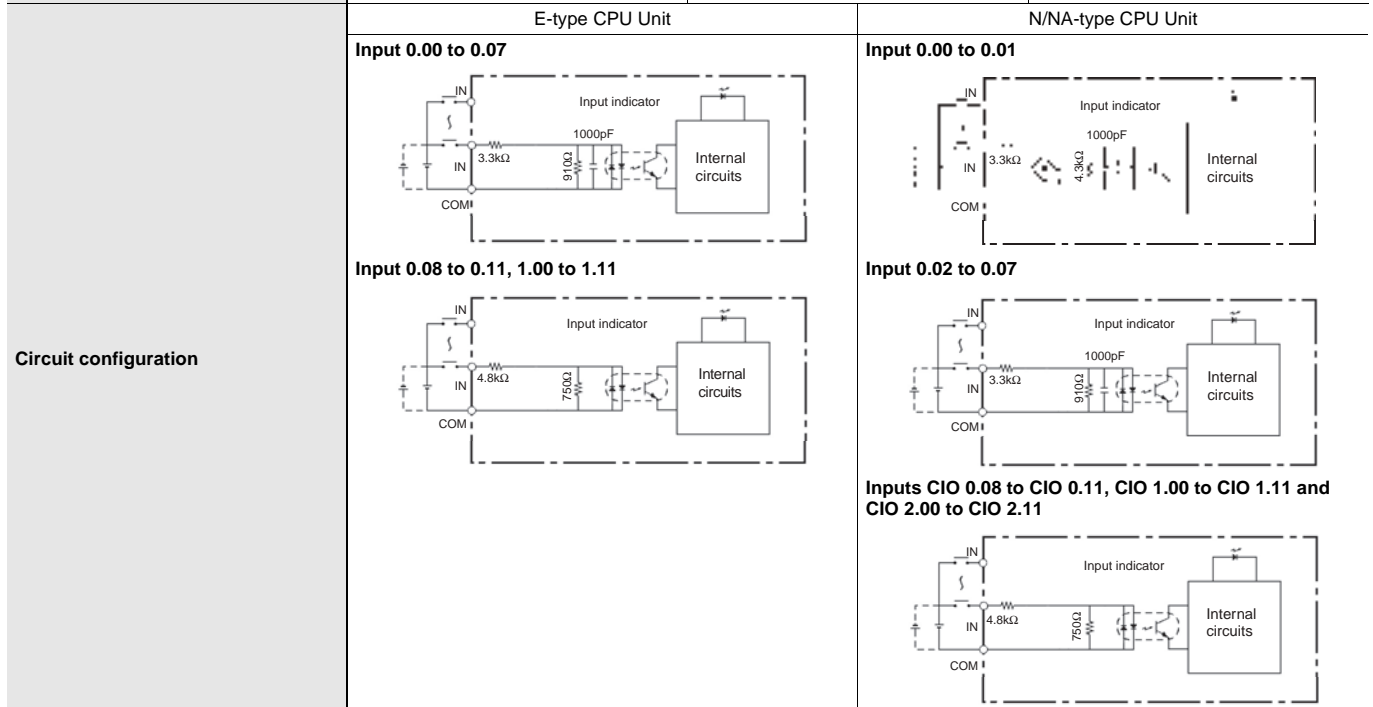

\* 1 The bits that can be used depend on the model of CPU Unit.

\* 2 The response time is the delay caused by hardware. The delay set in the PLC Setup (0 to 32 ms, default: 8 ms) for a normal input must be added to this value.

Pulse plus direction input mode,  
Increment mode  
Up/down input mode

Differential phase mode

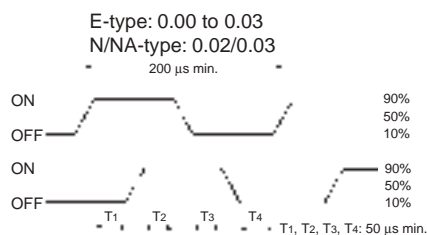
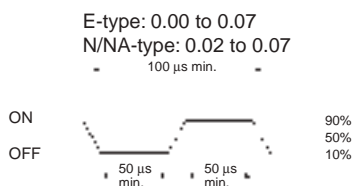
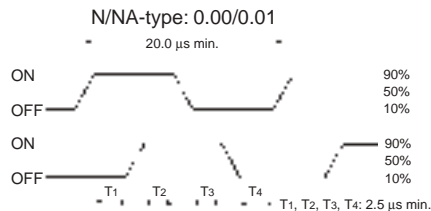
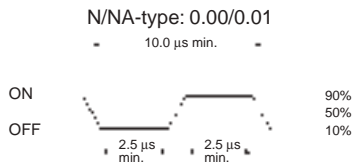

## Output Specifications

### ●Output Specifications for Relay Outputs

Item		Specification
Maximum switching capacity		250 VAC/2 A (cosφ = 1) 2 A, 24 VDC (4 A/common)
Minimum switching capacity		5 VDC, 10 mA
Service life of relay	Electrical	Resistive load 200,000 operations (24 VDC)
		Inductive load 70,000 operations (250 VAC, cosφ = 0.4)
	Mechanical	20,000,000 operations
ON delay		15 ms max.
OFF response time		15 ms max.
Circuit configuration		

### Estimating the Service Life of Relays

Under normal conditions, the service life of output contacts is as shown above. The service life of relays is as shown in the following diagram as a guideline

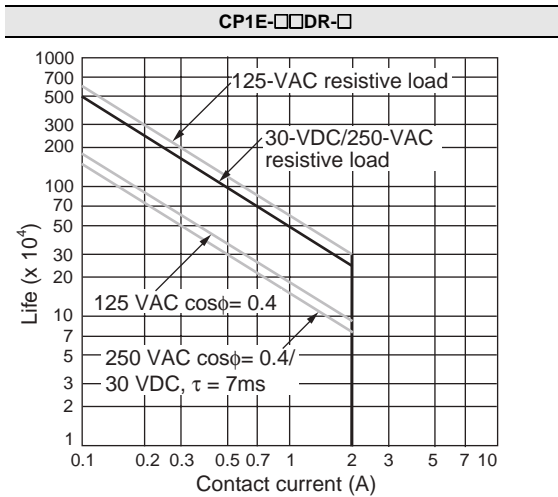

### Relationship between Continuous Simultaneous ON Rate and Ambient Temperature

There are restrictions on the power supply voltage and output load current imposed by the ambient temperature. Make sure that the power supply voltage and output load current are within the following ranges.

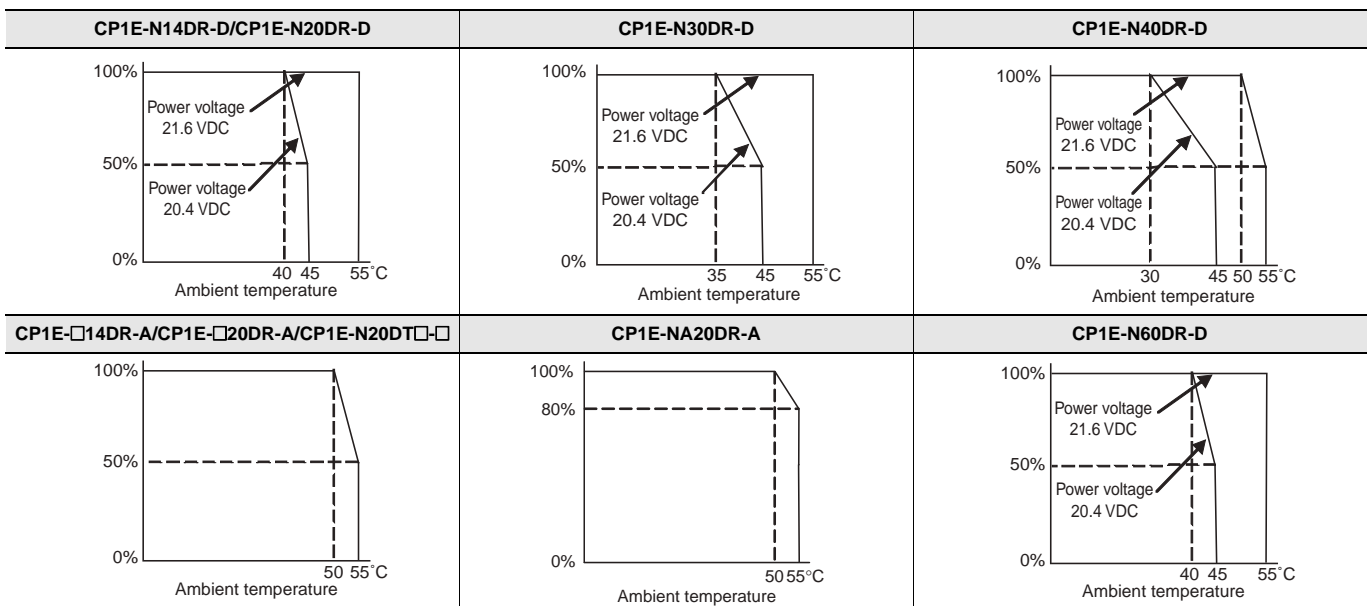

**Note:** The above restrictions apply to the relay output load current from the CPU Unit even if Expansion I/O Units are not connected.

●Output Specifications for Transistor Outputs (Sinking or Sourcing)

Normal Outputs

Item	Specification	
	CIO 100.00 and CIO 100.01	CIO 100.02 to CIO 100.07, CIO 101.00 to CIO 101.07 and CIO 102.00 to CIO 102.07 *2
Maximum switching capacity	0.3 A/output, 0.9 A/common *1 4.5 to 30 VDC CP1E-E10D□-□: 0.9 A/Unit CP1E-N14D□-□: 1.5 A/Unit CP1E-N20D□-□: 1.8 A/Unit CP1E-N30D□-□: 2.7 A/Unit CP1E-N40D□-□: 3.6 A/Unit CP1E-N60D□-□: 5.4 A/Unit CP1E-NA20D□-□: 1.8 A/Unit	
Minimum switching capacity	1 mA 4.5 to 30 VDC	
Leakage current	0.1mA max.	
Residual voltage	E-type CPU Unit: 1.5 V max. N/NA-type CPU Unit: 0.6 V max.	1.5V max.
ON response time	0.1 ms max.	
OFF response time	E-type CPU Unit: 1 ms max. N/NA-type CPU Unit: 0.1 ms max.	1 ms max.
Fuse	Not provided.	
Circuit configuration	<p><b>N/NA-type CPU Unit:</b> Normal outputs CIO 100.00 to CIO 100.01 (sinking)</p> <p><b>N/NA-type CPU Unit:</b> Normal outputs CIO 100.00 to CIO 100.01 (sourcing)</p>	<p><b>E-type CPU Unit:</b> Normal outputs CIO 100.00 to CIO 100.03 (sinking) <b>N/NA-type CPU Unit:</b> Normal outputs CIO 100.02 to CIO 102.07 (sinking)</p> <p><b>E-type CPU Unit:</b> Normal outputs CIO 100.01 to CIO 100.03 (sourcing) <b>N/NA-type CPU Unit:</b> Normal outputs CIO 100.02 to CIO 102.07 (sourcing)</p>

**Note:** Do not connect a load to an output terminal or apply a voltage in excess of the maximum switching capacity.  
 \* 1 Also do not exceed 0.9 A for the total for CIO 100.00 to CIO 100.03. (CIO 100.00 to CIO 100.03 is different common.)  
 \* 2 The bits that can be used depend on the model of CPU Unit.

Pulse Outputs (CIO 100.00 and CIO 100.01)

Item	Specification
Maximum switching capacity	100 mA/4.5 to 26.4 VDC
Minimum switching capacity	7 mA/4.5 to 26.4 VDC
Maximum output frequency	100 kHz
Output waveform	

**Note:** 1. The load for the above values is assumed to be the resistance load, and does not take into account the impedance for the connecting cable to the load.  
 2. Due to distortions in pulse waveforms resulting from connecting cable impedance, the pulse widths in actual operation may be smaller than the values shown above.

PWM Output (CIO 100.01)

Item	Specification
Maximum switching capacity	30 mA/4.5 to 26.4 VDC
Maximum output frequency	32 kHz
PWM output accuracy	For ON duty +1%, .0%:10 kHz output For ON duty +5%, .0%: 0 to 32 kHz output
Output waveform	

## Built-in Analog I/O (NA-type CPU Units)

### ●Analog Input Specifications

Item		Voltage input	Current input
Number of inputs		2 inputs (Allocated 2 words: CIO 90 to CIO 91.)	
Input signal range		0 to 5 V, 1 to 5 V, 0 to 10 V, or -10 to 10 V	
Max. rated input		±15 V	±30 mA
External input impedance		1 MΩ min.	Approx. 250Ω
Resolution		1/6000	
Overall accuracy	At 25°C	±0.3% full scale	±0.4% full scale
	0 to 55°C	±0.6% full scale	±0.8% full scale
A/D conversion data	-10 to +10 V	F448 to 0BB8 hex FS	
	Other ranges	0000 to 1770 hex FS	
Averaging function		Supported (Set for individual inputs in the PLC Setup.)	
Open-circuit detection function		Supported (Value when disconnected: 8000 hex)	

### ●Analog Output Specifications

Item		Voltage output	Current output
Number of outputs		1 output (Allocated 1 word: CIO 190.)	
Output signal range		0 to 5 V, 1 to 5 V, 0 to 10 V, or -10 to 10 V	
Allowable external output load resistance		1 kΩ min.	600Ω max.
External input impedance		0.5Ωmax.	---
Resolution		1/6000	
Overall accuracy	At 25°C	±0.4% full scale *	
	0 to 55°C	±0.8% full scale *	
D/A conversion data	-10 to +10 V	F448 to 0BB8 hex FS	
	Other ranges	0000 to 1770 hex FS	

\* In 0 to 20 mA mode, accuracy cannot be ensured at 0.2 mA or less.

### ●Shared I/O Specifications

Item	Specification
Conversion time	2 ms/point (6 ms total for 2 analog inputs and 1 analog output.)
Isolation method	Photocoupler isolation between analog I/O terminals and internal circuits. No isolation between analog I/O signals.



## Specifications of Expansion I/O Units and Expansion Units

### Expandable CPU Units

- Expansion I/O Units and Expansion Units cannot be connected to E10/14/20 or N14/20 CPU Units.
- A total of up to three Expansion I/O Units and Expansion Units can be connected to an E30/40, N30/40/60 or NA20 CPU Unit.

#### ●CP1E E10/14/20 or N14/20 CPU Unit

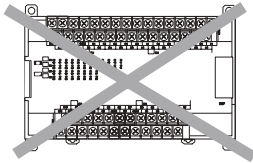
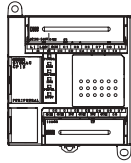

CP-series Expansion Units and Expansion I/O Units cannot be connected.

#### ●CP1E E30/40, N30/40/60 or NA20 CPU Unit

A total of up to three CP-series Expansion I/O Units and Expansion Units can be connected.

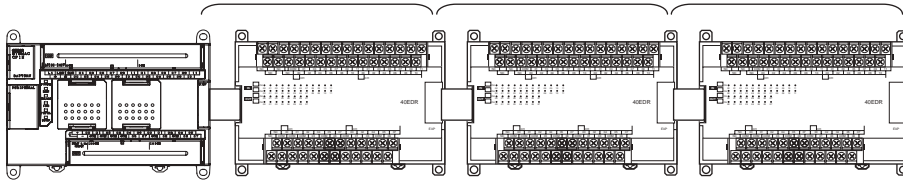

### Connection Methods

Connection cables for the Expansion I/O Units and Expansion Units are used to connect the Units. The length can be extended by using a CP1W-CN811 I/O Connection Cable (length: 800 m).

### Maximum Number of I/O Points for an Expanded System

CPU Unit	Built-in I/O on CPU Unit			Built-in Analog		Total number of Expansion I/O Units and Expansion Units that can be connected	Number of inputs: 24 Number of outputs: 16 Total number of I/O points when three CP1W-40ED□ Expansion I/O Units are connected		
	Total	Number of inputs	Number of outputs	AD	DA		Total	Number of inputs	Number of outputs
CP1E-E10D□-□	10	6	4	None	None	Not possible.	10	6	4
CP1E-□14D□-□	14	8	6				14	8	6
CP1E-□20D□-□	20	12	8				20	12	8
CP1E-□30D□-□	30	18	12			3 Units maximum	150	90	60
CP1E-□40D□-□	40	24	16				160	96	64
CP1E-N60D□-□	60	36	24				180	108	72
CP1E-NA20D□-□	20	12	8	2	1		140	84	56

### Restrictions on External Power Supply Capacity

The following restrictions apply when using the CPU Unit's external power supply.

#### ●AC-power-supply E30/40, N30/40/60 or NA20 CPU Unit

The power supply capacity is restricted for AC-power-supply E30/40, N30/40/60 or NA20 CPU Units. It may not be possible to use the full 300 mA of the external power supply, though a CPU Unit can connect any CP-series Expansion I/O Unit or Expansion Unit.

The entire 300 mA from the external power supply can be used if Expansion Units and Expansion I/O Units are not connected.

Refer to the CP1E CPU Unit Hardware Manual (Cat. No. W479) for details.

#### ●AC-power-supply or DC-power-supply E10/14/20, N14/20 CPU Unit

There is no external power supply on AC-power-supply or DC-power-supply E10/14/20, N14/20 CPU Units.

## Specifications of Expansion I/O Units

### ●Input Specifications (CP1W-40EDR/40EDT/40EDT1/20EDR1/20EDT/20EDT1/8ED)

Item	Specification
Input voltage	24 VDC +10%/-15%
Input impedance	4.7 kΩ
Input current	5 mA typical
ON voltage	14.4 VDC min.
OFF voltage	5.0 VDC max.
ON delay	1 ms max. *
OFF delay	1 ms max. *

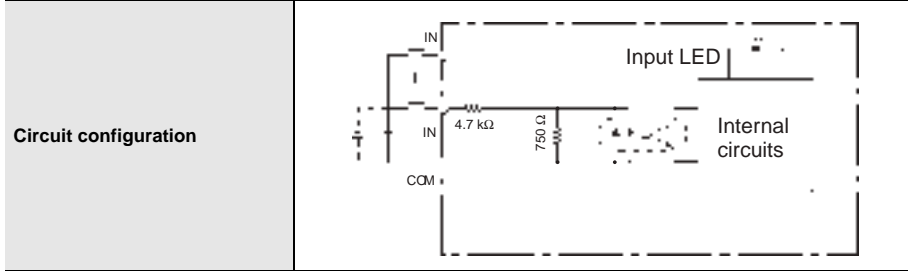

**Note:** Do not apply voltage in excess of the rated voltage to the input terminal.

\* The response time is the hardware delay value. The delay set in the PLC Setup (0 to 32 ms, default: 8 ms) must be added to this value. For the CP1W-40EDR/EDT/EDT1, a fixed value of 16 ms must be added.

### ●Output Specifications Relay Outputs (CP1W-40EDR/32ER/20EDR1/16ER/8ER)

Item	Specification	
Max. switching capacity	2 A, 250 VAC ( $\cos\phi = 1$ ), 2 A, 24 VDC (4 A/common)	
Min. switching capacity	5 VDC, 10 mA	
Service life of relay (See note.)	Electrical	
	Resistive load	150,000 operations (24 VDC)
	Inductive load	100,000 operations (240 VAC, $\cos\phi = 0.4$ )
	Mechanical	20,000,000 operations
ON delay	15 ms max.	
OFF delay	15 ms max.	

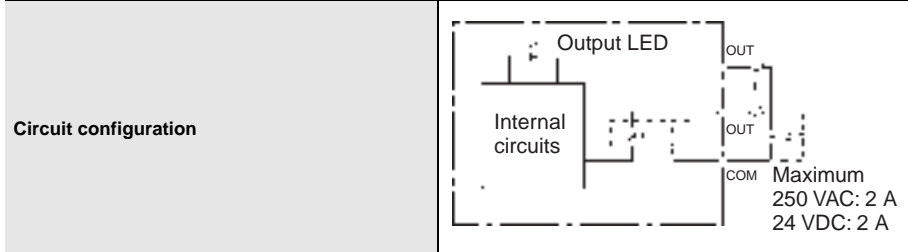

**Note: 1.** Estimating the Service Life of Relays

The service life of output contacts is as shown in the following diagram.

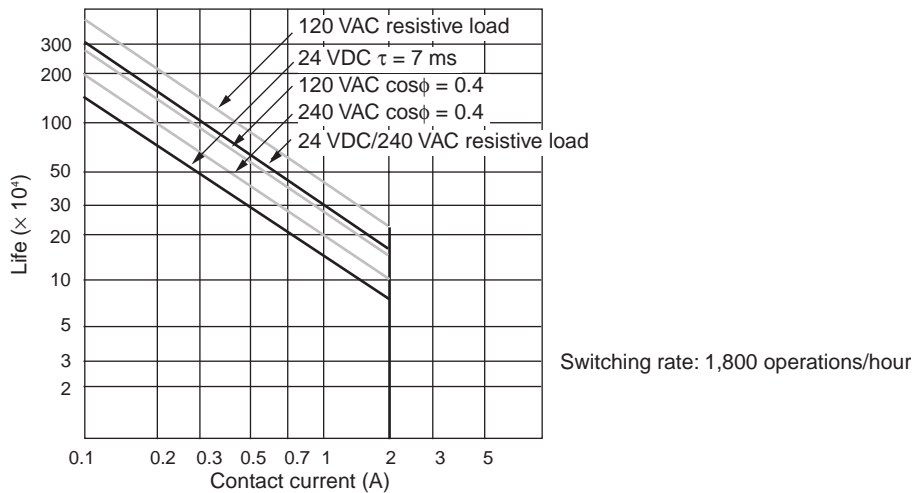

2. Restrictions of CP1W-16ER/32ER

Limit the output load current to satisfy the following derating curve.

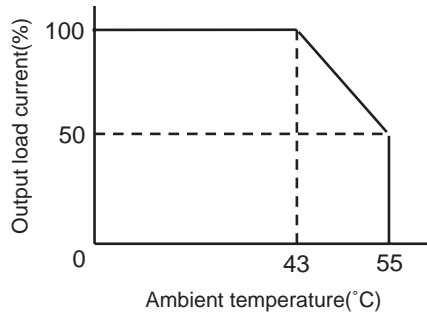

3. CP1W-32ER's maximum number of simultaneously ON output points is 24 (75%).  
Relation between Number of ON Outputs and Ambient Temperature (CP1W-32ER)

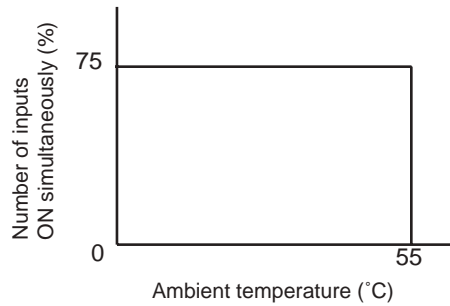

4. According to the ambient temperature, there are restrictions on power supply voltage and output load current for the CPU Units connected with the Expansion I/O Units (CP1W-8ER/16ER/20EDR1/32ER/40EDR). Use the PLC in the range of the power supply voltage and output load current as show below.  
The ambient temperature is restricted for the power-supply CPU Units (CP1E-N/NA□□□□-□). Derating curve of the output load current for Expansion I/O Units (CP1W-8ER/16ER/20EDR1/32ER/40EDR).

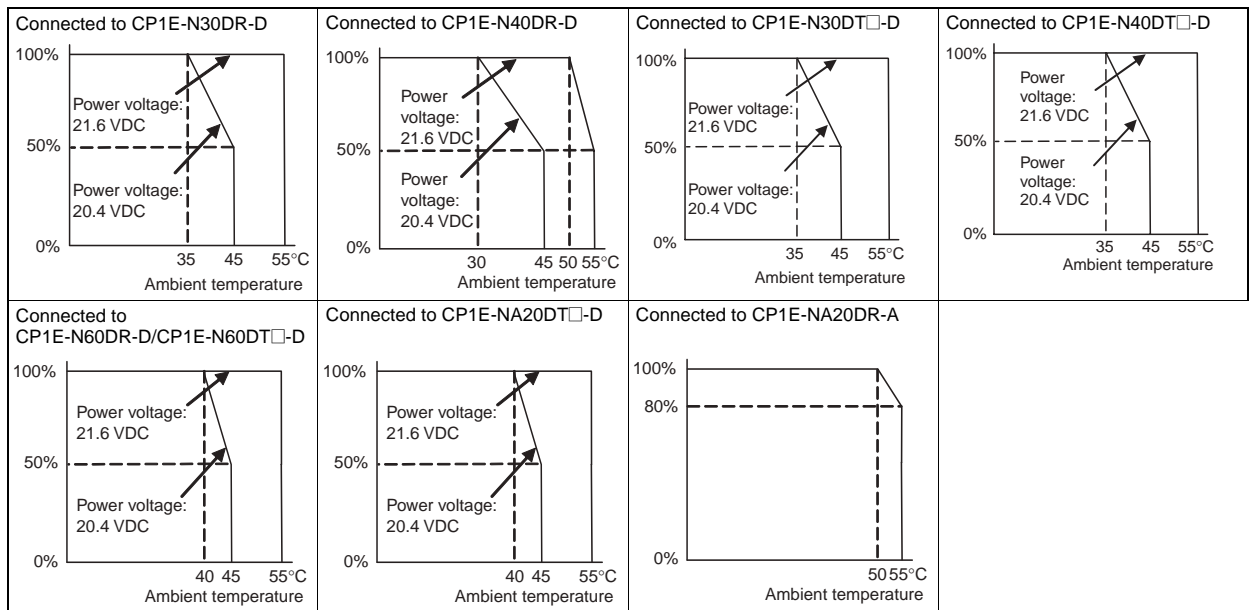

●Transistor Outputs (Sinking or Sourcing)

Item	Specification				
	CP1W-40EDT CP1W-40EDT1	CP1W-32ET CP1W-32ET1	CP1W-20EDT CP1W-20EDT1	CP1W-16ET CP1W-16ET1	CP1W-8ET CP1W-8ET1
<b>Max. switching capacity *1</b>	4.5 to 30 VDC 0.3 A/output 0.9 A/common 3.6 A/Unit	4.5 to 30 VDC 0.3 A/output 0.9 A/common 7.2 A/Unit	24 VDC +10%/-5% 0.3 A/output 0.9 A/common 1.8 A/Unit	4.5 to 30 VDC 0.3 A/output 0.9 A/common 3.6 A/Unit	4.5 to 30 VDC 0.3 A/output 0.9 A/common 1.8 A/Unit
<b>Leakage current</b>	0.1 mA max.	0.1 mA max.	0.1 mA max.	0.1 mA max.	0.1 mA max.
<b>Residual voltage</b>	1.5 V max.	1.5 V max.	1.5 V max.	1.5 V max.	1.5 V max.
<b>ON delay</b>	0.1 ms max.	0.1 ms max.	0.1 ms.	0.1 ms max.	0.1 ms max.
<b>OFF delay</b>	1 ms max. 24 VDC +10%/-5% 5 to 300 mA	1 ms max. 24 VDC +10%/-5% 5 to 300 mA	1 ms max. 24 VDC +10%/-5% 5 to 300 mA	1 ms max. 24 VDC +10%/-5% 5 to 300 mA	1 ms max. 24 VDC +10%/-5% 5 to 300 mA
<b>Max. number of Simultaneously ON Points of Output</b>	16 pts (100%)	24 pts (75%)	8 pts (100%)	16 pts (100%)	8 pts (100%)
<b>Fuse *2</b>	1 fuse/common				

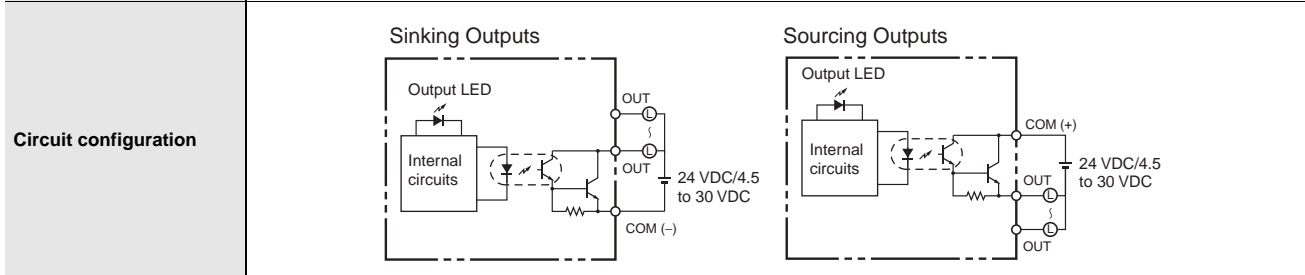

\*1 If the ambient temperature is maintained below 50°C, up to 0.9 A/common can be used.

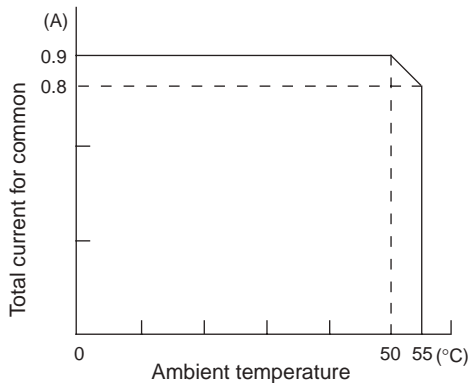

\*2 The fuse cannot be replaced by the user. Replace the Unit if the fuse breaks due to a short-circuit or overcurrent.  
 \*3 Do not connect a load to an output terminal or apply a voltage in excess of the maximum switching capacity.

## Specifications of Expansion Units

### ●Analog Input Units

Model		CP1W-AD041	
Item		Voltage Input	Current Input
Number of inputs		4 inputs (4 words allocated)	
Input signal range		0 to 5 VDC, 1 to 5 VDC, 0 to 10 VDC, or -10 to 10 VDC	0 to 20 mA or 4 to 20 mA
Max. rated input		±15 V	±30 mA
External input impedance		1 MΩ min.	Approx. 250 Ω
Resolution		1/6000 (full scale)	
Overall accuracy	25°C	0.3% full scale	0.4% full scale
	0 to 55°C	0.6% full scale	0.8% full scale
A/D conversion data		16-bit binary (4-digit hexadecimal) Full scale for -10 to 10 V: F448 to 0BB8 Hex Full scale for other ranges: 0000 to 1770 Hex	
Averaging function		Supported (Set in output words n+1 and n+2.)	
Open-circuit detection function		Supported	
Conversion time		2 ms/point (8 ms/all points)	
Isolation method		Photocoupler isolation between analog I/O terminals and internal circuits. No isolation between analog I/O signals.	
Current consumption		5 VDC: 100 mA max.; 24 VDC: 90 mA max.	

### ●Analog Output Units

Model		CP1W-DA041		
Item		Voltage Output	Current Output	
Analog output section	Number of outputs	4 outputs (4 words allocated)		
	Output signal range	1 to 5 VDC, 0 to 10 VDC, or -10 to 10 VDC	0 to 20 mA or 4 to 20 mA	
	External output allowable load resistance	2 kΩ min.	350 Ω max.	
	External output impedance	0.5 Ω max.	---	
	Resolution	1/6000 (full scale)		
	Overall accuracy	25°C	0.4% full scale	
		0 to 55°C	0.8% full scale	
D/A conversion data		16-bit binary (4-digit hexadecimal) Full scale for -10 to 10 V: F448 to 0BB8 Hex Full scale for other ranges: 0000 to 1770 Hex		
Conversion time		2 ms/point (8 ms/all points)		
Isolation method		Photocoupler isolation between analog I/O terminals and internal circuits. No isolation between analog I/O signals.		
Current consumption		5 VDC: 80 mA max.; 24 VDC: 124 mA max.		

●Analog I/O Units

Model		CP1W-MAD11		
Item		Voltage I/O	Current I/O	
Analog Input Section	Number of inputs	2 inputs (2 words allocated)		
	Input signal range	0 to 5 VDC, 1 to 5 VDC, 0 to 10 VDC, or -10 to 10 VDC	0 to 20 mA or 4 to 20 mA	
	Max. rated input	±15 V	±30 mA	
	External input impedance	1 MΩ min.	Approx. 250 Ω	
	Resolution	1/6000 (full scale)		
	Overall accuracy	25°C	0.3% full scale	0.4% full scale
		0 to 55°C	0.6% full scale	0.8% full scale
	A/D conversion data	16-bit binary (4-digit hexadecimal) Full scale for -10 to 10 V: F448 to 0BB8 hex Full scale for other ranges: 0000 to 1770 hex		
	Averaging function	Supported (Settable for individual inputs via DIP switch)		
Open-circuit detection function	Supported			
Analog Output Section	Number of outputs	1 output (1 word allocated)		
	Output signal range	1 to 5 VDC, 0 to 10 VDC, or -10 to 10 VDC,	0 to 20 mA or 4 to 20 mA	
	Allowable external output load resistance	1 kΩ min.	600 Ω max.	
	External output impedance	0.5 Ω max.		
	Resolution	1/6000 (full scale)		
	Overall accuracy	25°C	0.4% full scale	
		0 to 55°C	0.8% full scale	
Set data (D/A conversion)	16-bit binary (4-digit hexadecimal) Full scale for -10 to 10 V: F448 to 0BB8 hex Full scale for other ranges: 0000 to 1770 hex			
Conversion time	2 ms/point (6 ms/all points)			
Isolation method	Photocoupler isolation between analog I/O terminals and internal circuits. No isolation between analog I/O signals.			
Current consumption	5 VDC: 83 mA max., 24 VDC: 110 mA max.			

●Temperature Sensors Units

Item	CP1W-TS001	CP1W-TS002	CP1W-TS101	CP1W-TS102
Temperature sensors	Thermocouples		Platinum resistance thermometer	
	Switchable between K and J, but same type must be used for all inputs.		Switchable between Pt100 and JPt100, but same type must be used for all inputs.	
Number of inputs	2	4	2	4
Allocated input words	2	4	2	4
Accuracy	(The larger of ±0.5% of converted value or ±2°C) ±1 digit max. *		(The larger of ±0.5% of converted value or ±1°C) ±1 digit max.	
Conversion time	250 ms for 2 or 4 input points			
Converted temperature data	16-bit binary data (4-digit hexadecimal)			
Isolation	Photocouplers between all temperature input signals			
Current consumption	5 VDC: 40 mA max., 24 VDC: 59 mA max.		5 VDC: 54 mA max., 24 VDC: 73 mA max.	

\* Accuracy for a K-type sensor at -100°C or less is ±4°C ±1 digit max.

The rotary switch is used to set the temperature range.

Setting	CP1W-TS001/TS002			CP1W-TS101/TS102		
	Input type	Range (°C)	Range (°F)	Input type	Range (°C)	Range (°F)
0	K	-200 to 1,300	-300 to 2,300	Pt100	-200.0 to 650.0	-300.0 to 1,200.0
		0.0 to 500.0	0.0 to 900.0	JPt100	-200.0 to 650.0	-300.0 to 1,200.0
2	J	-100 to 850	-100 to 1,500	---	Cannot be set.	
		0.0 to 400.0	0.0 to 750.0	---		
4 to F	---	Cannot be set.		---		

●CompoBus/S I/O Link Unit

Model number	CP1W-SRT21
Master/slave	CompoBus/S Slave
Number of I/O points	8 input points, 8 output points
Number of words allocated in CPU Unit I/O memory	1 input word, 1 output word
Node number setting	Set using the DIP switch (Set before turning on the CPU Unit's power supply.)

## External Interfaces

The CP1E CPU Units provide the following external interfaces.

### E10/14/20 or N14/20 CPU Units

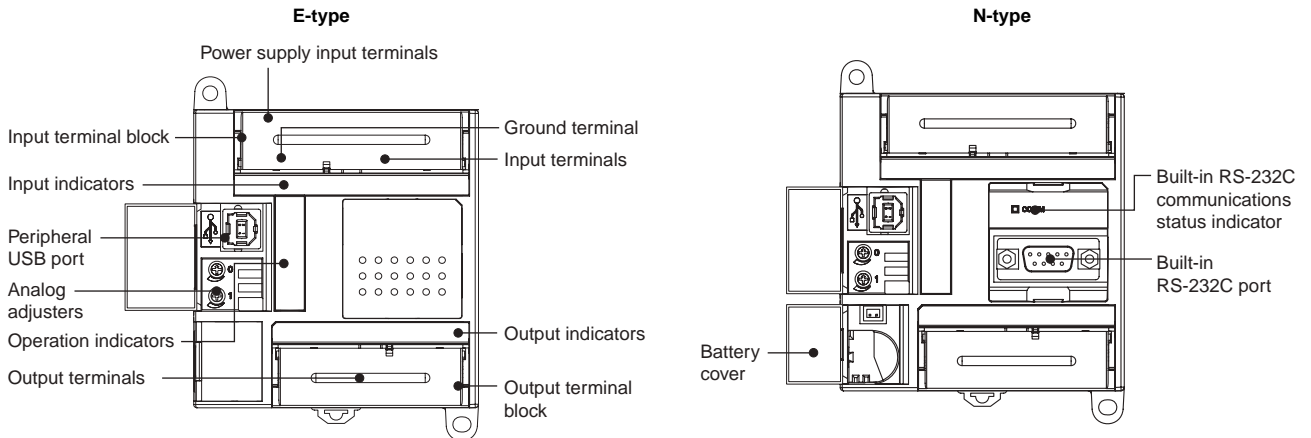

**Note:** Terminal Block (Fixed)

### E30/40, N30/40/60 or NA20 CPU Units

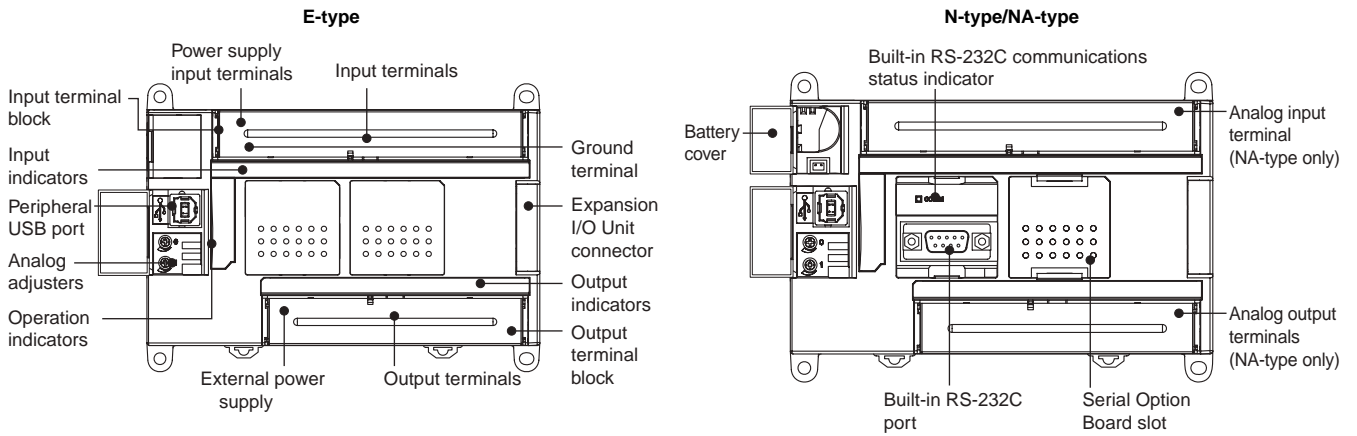

**Note:** Terminal Block (Fixed)

### Built-in RS-232C Port for N/NA-type CPU Units

#### ●RS-232C Connector

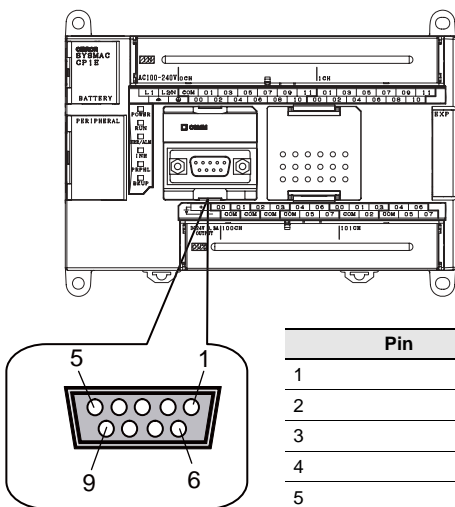

Pin	Abbr.	Signal name	Signal direction
1	FG	Frame ground	--
2	SD (TXD)	Send data	Output
3	RD (RXD)	Receive data	Input
4	RS (RTS)	Request to send	Output
5	CS (CTS)	Clear to send	Input
6	5 V	Power supply	--
7	DR (DSR)	Data set ready	Input
8	ER (DTR)	Data terminal ready	Output
9	SG (0 V)	Signal ground	--
Connector hood	FG	Frame Ground	--

**Note:** Do not use the 5-V power from pin 6 of the RS-232C port for anything but CJ1W-CIF11 RS-422A Conversion Adapter, NT-AL001 RS-232C/RS-422A Conversion Adapter and NV3W-M□20L Programmable Terminal. The external device or the CPU Unit may be damaged.

## Optional Serial Communications Board for N30/40/60 or NA20 CPU Units

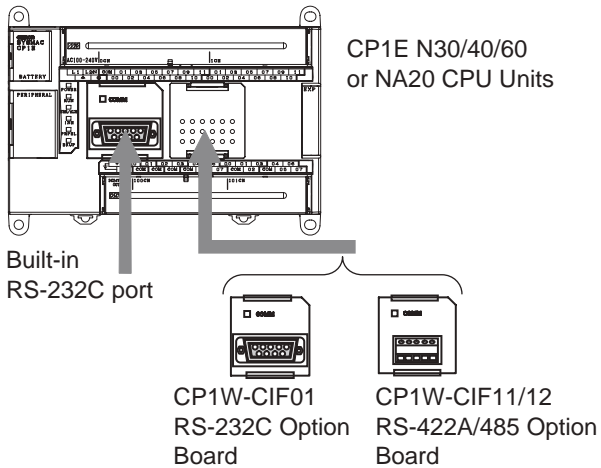

Model number	Port	Maximum transmission distance	Connection method
CP1W-CIF01	One RS-232C port	15 m	Connector (D-sub, 9 pin female)
CP1W-CIF11	One RS-422A/485 port (not isolated)	50 m	Terminal block (using ferrules)
CP1W-CIF12	One RS-422A/485 port (isolated)	500 m	Terminal block (using ferrules)

### CP1W-CIF01 RS-232C Option Board

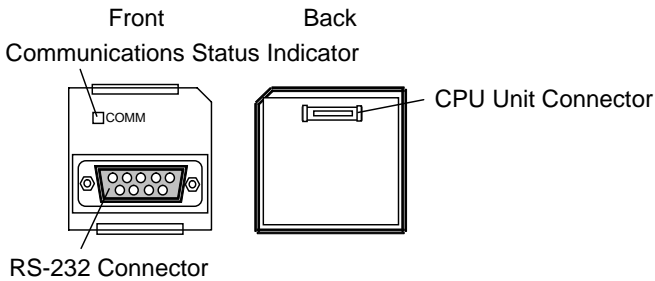

#### ●RS-232C Connector

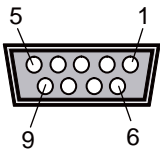

Pin	Abbr.	Signal name	Signal direction
1	FG	Frame ground	--
2	SD (TXD)	Send data	Output
3	RD (RXD)	Receive data	Input
4	RS (RTS)	Request to send	Output
5	CS (CTS)	Clear to send	Input
6	5 V	Power supply	--
7	DR (DSR)	Data set ready	Input
8	ER (DTR)	Data terminal ready	Output
9	SG (0 V)	Signal ground	--
Connector hood	FG	Frame Ground	--

**Note:** Do not use the 5-V power from pin 6 of the RS-232C port for anything but CJ1W-CIF11 RS-422A Conversion Adapter, NT-AL001 RS-232C/RS-422A Conversion Adapter and NV3W-M□20L Programmable Terminal. The external device or the CPU Unit may be damaged.

### CP1W-CIF11/CIF12 RS-422A/485 Option Board

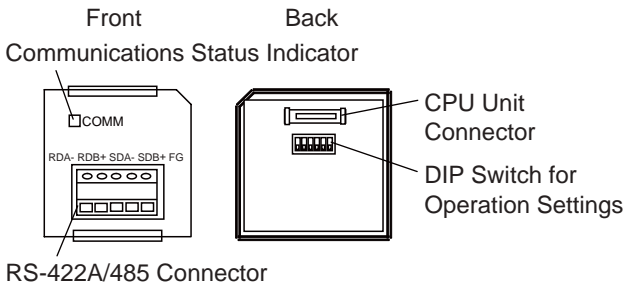

#### ●RS-422A/485 Terminal Block

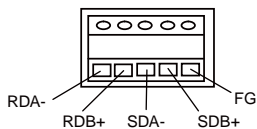

Tighten the terminal block screws to a torque of 0.28 N·m.



## Connecting to Support Software

### Operating Environment and System Configuration

The following system is required to operate the CX-Programmer. Make sure your system provides the following conditions and has the necessary components.

Item	Description
Supported computer	IBM PC/AT or equivalent
CD-ROM or DVD-ROM drive	One or more
Supported Operating Systems	Windows 7, Windows Vista, Windows XP, Windows 2000 (Service Pack 4 or later) (except 64-bit edition)
CPU	Pentium II 333 MHz or faster
RAM	256 MB min. 512 MB or more recommended
Available hard disk space	600 MB min.
Display	800 x 600 SVGA min.
PLC and connection port	USB port or RS-232C port

### Connecting Methods

Using commercially available USB cable, connect the CX-Programmer to the peripheral USB port on the CPU Unit. Host link connection can be made with RS-232C port to connect the Programming Device (CX-Programmer).

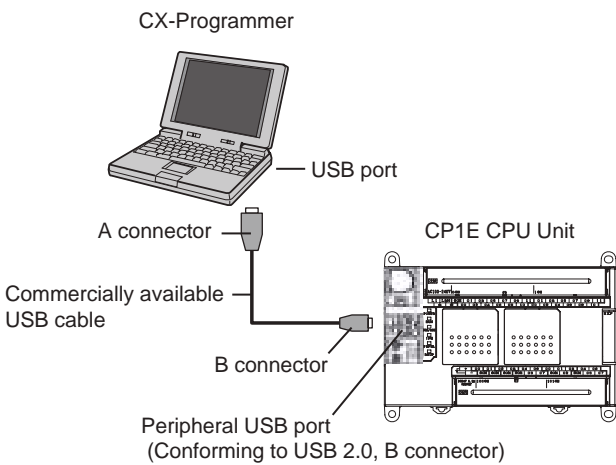

### Connecting Cable

Use the following cable to connect the CP1E CPU Unit to the computer running the Support Software.

#### USB port

Port at Unit	Port at computer	Network type (communications mode)	Model numbers	Length
Peripheral USB port (Conforming to USB 2.0, B connector)	USB port	USB 2.0 (or 1.1)	Commercially available USB cable (A connector - B connector)	Less than 5 m

#### RS-232C Port for N/NA-type CPU Units

Port at Unit	Port at computer	Communications mode	Connecting Cable		
			Model	Length	Remarks
RS-232C Port or CP1W-CIF01 (Add this to the option board slot.)	RS-232C port *	Host Link (SYSWAY)	XW2Z-200S-CV	2m	With anti-static connectors
			XW2Z-500S-CV	5m	With anti-static connectors
			XW2Z-200S-V	2m	---
			XW2Z-500S-V	5m	---

**Note:** Connectable with CX-Programmer Ver.9.1 or higher only.

\* Use the USB-Serial Conversion Cable CS1W-CIF31 together to connect a PLC to a personal computer's USB port.

# CP1E-E□□D□-□ CP1E-N□□D□-□/NA20D□-□

## Unit Versions

Units	Model numbers	Unit version
CP1E CPU Units	CP1E-E□□D□-□ CP1E-N□□D□-□ CP1E-NA□□D□-□	Unit version 1.□

## Unit Versions and Programming Devices

The following tables show the relationship between unit versions and CX-Programmer versions.

### Unit Versions and Programming Devices

CPU Unit	Functions	Required Programming Device *							
		CX-Programmer			Micro PLC Edition CX-Programmer				CX-Programmer for CP1E
		Ver.8.1 or lower	Ver.8.2	Ver.9.03 or higher	Ver.8.1 or lower	Ver.8.2	Ver.9.0	Ver.9.03 or higher	Ver.1.0
CP1E-E10D□-□ CP1E-□14D□-□ CP1E-N60D□-□ CP1E-NA20D□-□	Unit version 1.□ functions	Not support.	Not support.	Yes Supports Smart Input function.	Not support.	Not support.	Not support.	Yes Supports Smart Input function.	Not support.
CP1E-E20/30/40D□-A CP1E-N20/30/40D□-□	Unit version 1.□ functions	Not support.	Yes Does not support Smart Input function.	Yes Supports Smart Input function.	Not support.	Yes Does not support Smart Input function.	Yes Supports Smart Input function.	Yes Supports Smart Input function.	Yes Supports Smart Input function.

\* A Programming Console cannot be used.

## Programming Instructions

### Sequence Input Instructions

Instruction	Mnemonic
LOAD	LD
LOAD NOT	LD NOT
AND	AND
AND NOT	AND NOT
OR	OR
OR NOT	OR NOT
AND LOAD	AND LD
OR LOAD	OR LD
NOT	NOT
CONDITION ON	UP
CONDITION OFF	DOWN

### Sequence Output Instructions

Instruction	Mnemonic
OUTPUT	OUT
OUTPUT NOT	OUT NOT
KEEP	KEEP
DIFFERENTIATE UP	DIFU
DIFFERENTIATE DOWN	DIFD
SET	SET
RESET	RSET
MULTIPLE BIT SET	SETA
MULTIPLE BIT RESET	RSTA
SINGLE BIT SET	SETB
SINGLE BIT RESET	RSTB

### Sequence Output Instructions

Instruction	Mnemonic
END	END
NO OPERATION	NOP
INTERLOCK	IL
INTERLOCK CLEAR	ILC
MULTI-INTERLOCK DIFFERENTIATION HOLD	MILH
MULTI-INTERLOCK DIFFERENTIATION RELEASE	MILR
MULTI-INTERLOCK CLEAR	MILC
JUMP	JMP
JUMP END	JME
CONDITIONAL JUMP	CJP
FOR LOOP	FOR
BREAK LOOP	BREAK
NEXT LOOP	NEXT

### Timer and Counter Instructions

Instruction	Mnemonic
TIMER	TIM
	TIMX
COUNTER	CNT
	CNTX
HIGH-SPEED TIMER	TIMH
	TIMHX
ONE-MS TIMER	TMHH
	TMHHX
ACCUMULATIVE TIMER	TTIM
	TTIMX
LONG TIMER	TIML
	TIMLX
REVERSIBLE COUNTER	CNTR
	CNTRX
RESET TIMER/COUNTER	CNR
	CNRX

### Comparison Instructions

Instruction	Mnemonic
Input Comparison Instructions (unsigned)	LD,AND,OR+=
	LD,AND,OR+<>
	LD,AND,OR+<
	LD,AND,OR+<=
	LD,AND,OR+>
Input Comparison Instructions (double, unsigned)	LD,AND,OR+>=
	LD,AND,OR+=+L
	LD,AND,OR+<>+L
	LD,AND,OR+<+L
	LD,AND,OR+<=+L
Input Comparison Instructions (signed)	LD,AND,OR+>+L
	LD,AND,OR+>=+L
	LD,AND,OR+=+S
	LD,AND,OR+<>+S
	LD,AND,OR+<+S
Input Comparison Instructions (double, signed)	LD,AND,OR+<=+S
	LD,AND,OR+>+S
	LD,AND,OR+>=+S
	LD,AND,OR+=+SL
	LD,AND,OR+<>+SL
Time Comparison Instructions	LD,AND,OR+<+SL
	LD,AND,OR+<=+SL
	LD,AND,OR+>+SL
	LD,AND,OR+>=+SL
	=DT
<>DT	
<DT	
<=DT	
>DT	
>=DT	
COMPARE	CMP
DOUBLE COMPARE	CMPL
SIGNED BINARY COMPARE	CPS
DOUBLE SIGNED BINARY COMPARE	CPSL
TABLE COMPARE	TCMP
UNSIGNED BLOCK COMPARE	BCMP
AREA RANGE COMPARE	ZCP
DOUBLE AREA RANGE COMPARE	ZCPL

### Data Movement Instructions

Instruction	Mnemonic
MOVE	MOV
DOUBLE MOVE	MOVL
MOVE NOT	MVN
MOVE BIT	MOVB
MOVE DIGIT	MOVD
MULTIPLE BIT TRANSFER	XFRB
BLOCK TRANSFER	XFER
BLOCK SET	BSET
DATA EXCHANGE	XCHG
SINGLE WORD DISTRIBUTE	DIST
DATA COLLECT	COLL

### Data Shift Instructions

Instruction	Mnemonic
SHIFT REGISTER	SFT
REVERSIBLE SHIFT REGISTER	SFTR
WORD SHIFT	WSFT
ARITHMETIC SHIFT LEFT	ASL
ARITHMETIC SHIFT RIGHT	ASR
ROTATE LEFT	ROL
ROTATE RIGHT	ROR
ONE DIGIT SHIFT LEFT	SLD
ONE DIGIT SHIFT RIGHT	SRD
SHIFT N-BITS LEFT	NASL
DOUBLE SHIFT N-BITS LEFT	NSLL
SHIFT N-BITS RIGHT	NASR
DOUBLE SHIFT N-BITS RIGHT	NSRL

### Increment/Decrement Instructions

Instruction	Mnemonic
INCREMENT BINARY	++
DOUBLE INCREMENT BINARY	++L
DECREMENT BINARY	--
DOUBLE DECREMENT BINARY	--L
INCREMENT BCD	++B
DOUBLE INCREMENT BCD	++BL
DECREMENT BCD	--B
DOUBLE DECREMENT BCD	--BL

### Symbol Math Instructions

Instruction	Mnemonic
SIGNED BINARY ADD WITHOUT CARRY	+
DOUBLE SIGNED BINARY ADD WITHOUT CARRY	+L
SIGNED BINARY ADD WITH CARRY	+C
DOUBLE SIGNED BINARY ADD WITH CARRY	+CL
BCD ADD WITHOUT CARRY	+B
DOUBLE BCD ADD WITHOUT CARRY	+BL
BCD ADD WITH CARRY	+BC
DOUBLE BCD ADD WITH CARRY	+BCL
SIGNED BINARY SUBTRACT WITHOUT CARRY	-
DOUBLE SIGNED BINARY SUBTRACT WITHOUT CARRY	-L
SIGNED BINARY SUBTRACT WITH CARRY	-C
DOUBLE SIGNED BINARY SUBTRACT WITH CARRY	-CL
BCD SUBTRACT WITHOUT CARRY	-B
DOUBLE BCD SUBTRACT WITHOUT CARRY	-BL
BCD SUBTRACT WITH CARRY	-BC
DOUBLE BCD SUBTRACT WITH CARRY	-BCL
SIGNED BINARY MULTIPLY	*
DOUBLE SIGNED BINARY MULTIPLY	*L
BCD MULTIPLY	*B
DOUBLE BCD MULTIPLY	*BL
SIGNED BINARY DIVIDE	/
DOUBLE SIGNED BINARY DIVIDE	/L
BCD DIVIDE	/B
DOUBLE BCD DIVIDE	/BL

### Conversion Instructions

Instruction	Mnemonic
BCD-TO-BINARY	BIN
DOUBLE BCD-TO-DOUBLE BINARY	BINL
BINARY-TO-BCD	BCD
DOUBLE BINARY-TO-DOUBLE BCD	BCDL
2'S COMPLEMENT	NEG
DATA DECODER	MLPX
DATA ENCODER	DMPX
ASCII CONVERT	ASC
ASCII TO HEX	HEX

### Logic Instructions

Instruction	Mnemonic
LOGICAL AND	ANDW
DOUBLE LOGICAL AND	ANDL
LOGICAL OR	ORW
DOUBLE LOGICAL OR	ORWL
EXCLUSIVE OR	XORW
DOUBLE EXCLUSIVE OR	XORL
COMPLEMENT	COM
DOUBLE COMPLEMENT	COML

### Special Math Instructions

Instruction	Mnemonic
ARITHMETIC PROCESS	APR
BIT COUNTER	BCNT

### Floating-point Math Instructions

Instruction	Mnemonic
FLOATING TO 16-BIT	FIX
FLOATING TO 32-BIT	FIXL
16-BIT TO FLOATING	FLT
32-BIT TO FLOATING	FLT L
FLOATING-POINT ADD	+F
FLOATING-POINT SUBTRACT	-F
FLOATING-POINT DIVIDE	/F
FLOATING-POINT MULTIPLY	*F
Floating Symbol Comparison	LD, AND, OR+=F
	LD, AND, OR+<>F
	LD, AND, OR+<F
	LD, AND, OR+<=F
	LD, AND, OR+>F
LD, AND, OR+>=F	
FLOATING- POINT TO ASCII	FSTR
ASCII TO FLOATING-POINT	FVAL

### Table Data Processing Instructions

Instruction	Mnemonic
SWAP BYTES	SWAP
FRAME CHECKSUM	FCS

### Data Control Instructions

Instruction	Mnemonic
PID CONTROL WITH AUTOTUNING	PIDAT
TIME-PROPORTIONAL OUTPUT	TPO
SCALING	SCL
SCALING 2	SCL2
SCALING 3	SCL3
AVERAGE	AVG

## Subroutine Instructions

Instruction	Mnemonic
SUBROUTINE CALL	SBS
SUBROUTINE ENTRY	SBN
SUBROUTINE RETURN	RET

## Interrupt Control Instructions

Instruction	Mnemonic
SET INTERRUPT MASK	MSKS
CLEAR INTERRUPT	CLI
DISABLE INTERRUPTS	DI
ENABLE INTERRUPTS	EI

## High-speed Counter and Pulse Output Instructions

Instruction	Mnemonic
MODE CONTROL	INI
HIGH-SPEED COUNTER PV READ	PRV
COMPARISON TABLE LOAD	CTBL
SPEED OUTPUT	SPED
SET PULSES	PULS
PULSE OUTPUT	PLS2
ACCELERATION CONTROL	ACC
ORIGIN SEARCH	ORG
PULSE WITH VARIABLE DUTY FACTOR	PWM

## Step Instructions

Instruction	Mnemonic
STEP DEFINE	STEP
STEP START	SNXT

## I/O Unit Instructions

Instruction	Mnemonic
I/O REFRESH	IORF
7-SEGMENT DECODER	SDEC
DIGITAL SWITCH INPUT	DSW
MATRIX INPUT	MTR
7-SEGMENT DISPLAY OUTPUT	7SEG

## Serial Communications Instructions

Instruction	Mnemonic
TRANSMIT	TXD
RECEIVE	RXD

## Clock Instructions

Instruction	Mnemonic
CALENDAR ADD	CADD
CALENDAR SUBTRACT	CSUB
CLOCK ADJUSTMENT	DATE

## Failure Diagnosis Instructions

Instruction	Mnemonic
FAILURE ALARM	FAL
SEVERE FAILURE ALARM	FALS

## Other Instructions

Instruction	Mnemonic
SET CARRY	STC
CLEAR CARRY	CLC
EXTEND MAXIMUM CYCLE TIME	WDT

Dimensions

(Unit: mm)

CP1E CPU Unit

●CPU Units with 10 I/O Points

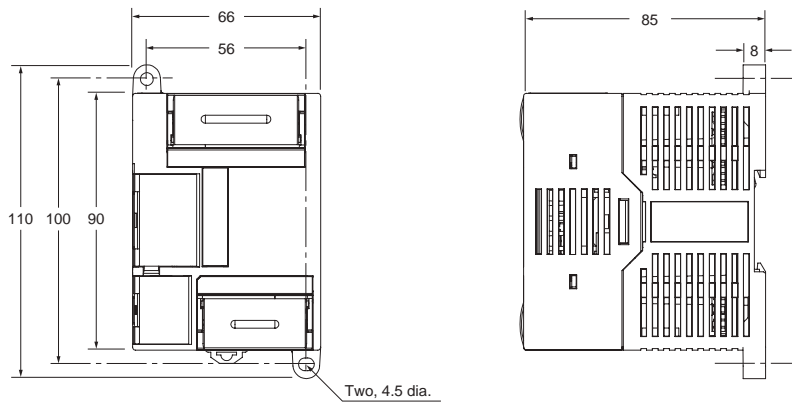

●CPU Units with 14 or 20 I/O Points

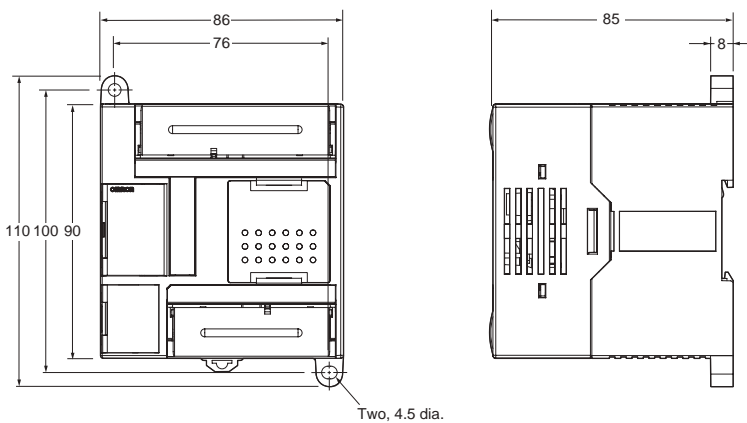

●CPU Units with 30 I/O Points

CPU Units with 20 I/O Points and Built-in Analog

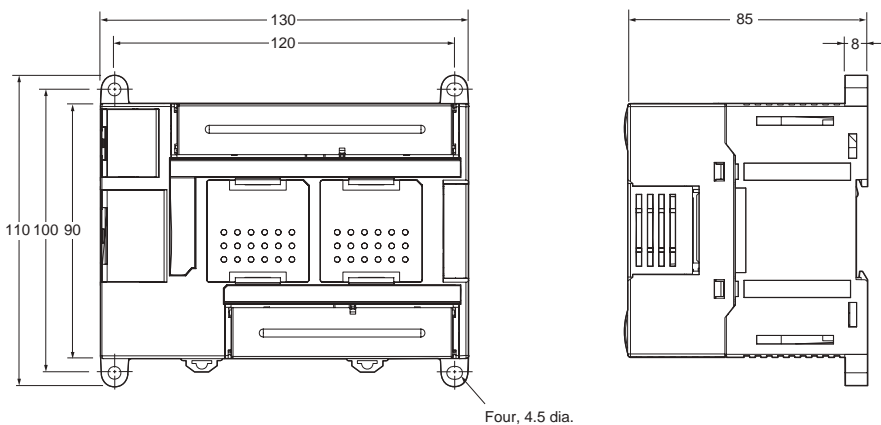

●CPU Units with 40 I/O Points

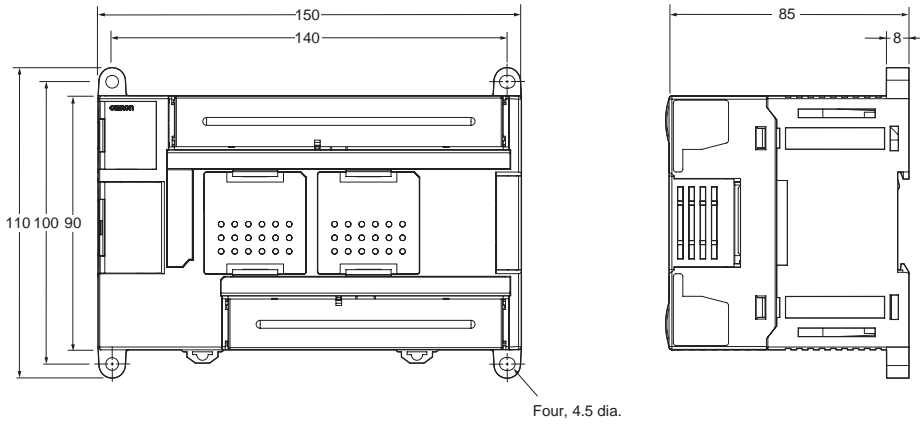

●CPU Units with 60 I/O Points

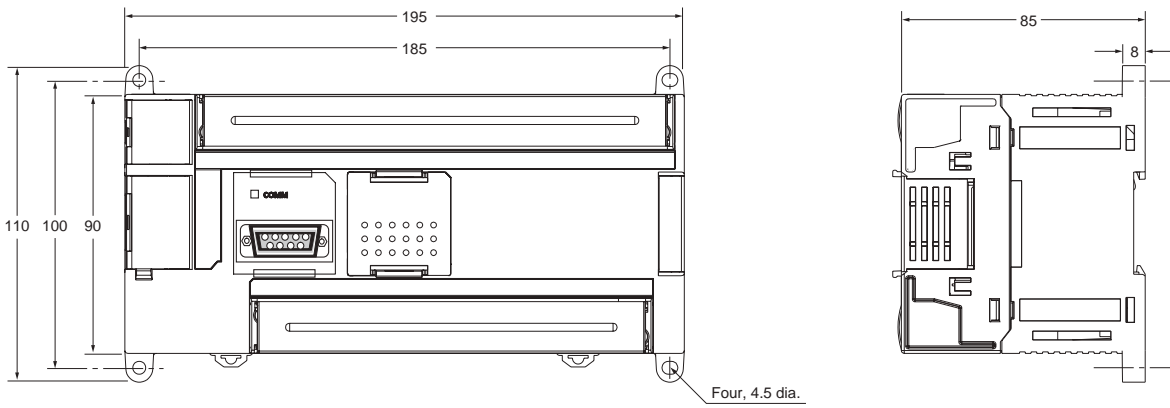

**CP1E-E□□D□-□ CP1E-N□□D□-□/NA20D□-□**

**Expansion I/O Units and Expansion Units**

●CP1W-8E□□/CP1W-SRT21

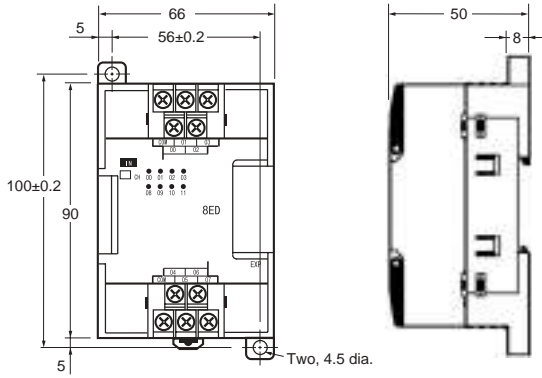

●CP1W-20ED□/CP1W-16E□□/CP1W-AD041/CP1W-DA041/CP1W-MAD11/CP1W-TS□□□

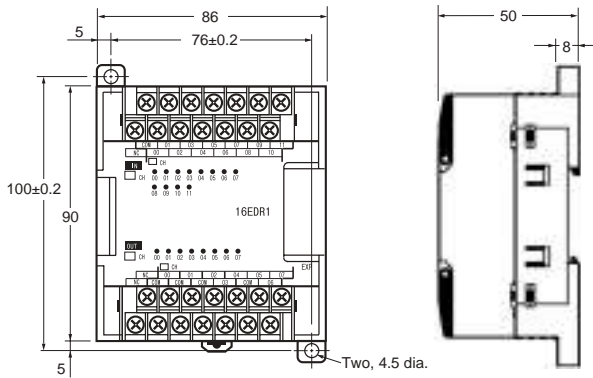

●CP1W-40ED□/CP1W-32E□□

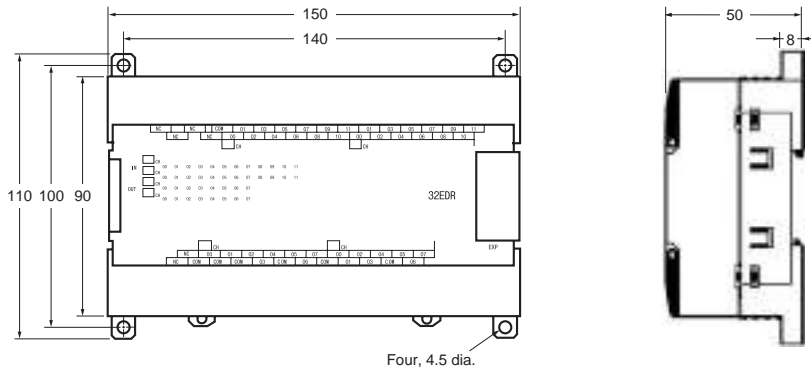



## Related Manuals

Manual name	Cat. No.	Model numbers	Application	Contents
SYSMAC CP Series CP1E CPU Unit Hardware Manual	W479	CP1E-E□□D□-□ CP1E-N□□D□-□ CP1E-NA□□D□-□	To learn the hardware specifications of the CP1E PLCs	Describes the following information for CP1E PLCs. <ul style="list-style-type: none"> <li>• Overview and features</li> <li>• Basic system configuration</li> <li>• Part names and functions</li> <li>• Installation and settings</li> <li>• Troubleshooting</li> </ul>
			Use this manual together with the CP1E CPU Unit Software Manual (Cat. No. W480) and CP1E CPU Unit Instructions Reference Manual (Cat. No. W483).	
SYSMAC CP Series CP1E CPU Unit Software Manual	W480	CP1E-E□□D□-□ CP1E-N□□D□-□ CP1E-NA□□D□-□	To learn the software specifications of the CP1E	Describes the following information for CP1E PLCs. <ul style="list-style-type: none"> <li>• CPU Unit operation</li> <li>• Internal memory</li> <li>• Programming</li> <li>• Settings</li> <li>• CPU Unit built-in functions</li> <li>• Interrupts</li> <li>• High-speed counter inputs</li> <li>• Pulse outputs</li> <li>• Serial communications</li> <li>• Analog I/O function</li> <li>• Other functions</li> </ul>
			Use this manual together with the CP1E CPU Unit Hardware Manual (Cat. No. W479) and CP1E CPU Unit Instructions Reference Manual (Cat. No. W483).	
SYSMAC CP Series CP1E CPU Unit Instructions Reference Manual	W483	CP1E-E□□D□-□ CP1E-N□□D□-□ CP1E-NA□□D□-□	To learn programming instructions in detail	Describes each programming instruction in detail. When programming, use this manual together with the CP1E CPU Unit Hardware Manual (Cat. No. W479) and CP1E CPU Unit Software Manual (Cat. No. W480).
CS/CJ/CP/NSJ Series Communications Commands Reference Manual	W342	CS1G/H-CPU□□H CS1G/H-CPU□□-V1 CS1D-CPU□□H CS1D-CPU□□S CS1W-SCU□□-V1 CS1W-SCB□□-V1 CJ1G/H-CPU□□H CJ1G-CPU□□P CJ1M-CPU□□ CJ1G-CPU□□ CJ1W-SCU□□-V1	To learn communications commands for CS/CJ/CP/NSJ-series Controllers in detail	Describes 1) C-mode commands and 2) FINS commands in detail. Read this manual for details on C-mode and FINS commands addressed to CPU Units.
			<b>Note:</b> This manual describes commands addressed to CPU Units. It does not cover commands addressed to other Units or ports (e.g., serial communications ports on CPU Units, communications ports on Serial Communications Units/Boards, and other Communications Units).	
SYSMAC CP Series CP1L/CP1E CPU Unit Introduction Manual	W461	CP1L-L10D□-□ CP1L-L14D□-□ CP1L-L20D□-□ CP1L-M30D□-□ CP1L-M40D□-□ CP1L-M60D□-□ CP1E-E□□D□-□ CP1E-N□□D□-□ CP1E-NA□□D□-□	To learn the basic setup methods of the CP1L/CP1E PLCs	Describes the following information for CP1L/CP1E PLCs. <ul style="list-style-type: none"> <li>• Basic configuration and component names</li> <li>• Mounting and wiring</li> <li>• Programming, data transfer, and debugging using the CX-Programmer</li> <li>• Application program examples</li> </ul>



## Read and Understand this Catalog

Please read and understand this catalog before purchasing the product. Please consult your OMRON representative if you have any questions or comments.

## Warranty and Limitations of Liability

### WARRANTY

OMRON's exclusive warranty is that the products are free from defects in materials and workmanship for a period of one year (or other period if specified) from date of sale by OMRON.

OMRON MAKES NO WARRANTY OR REPRESENTATION, EXPRESS OR IMPLIED, REGARDING NON-INFRINGEMENT, MERCHANTABILITY, OR FITNESS FOR PARTICULAR PURPOSE OF THE PRODUCTS. ANY BUYER OR USER ACKNOWLEDGES THAT THE BUYER OR USER ALONE HAS DETERMINED THAT THE PRODUCTS WILL SUITABLY MEET THE REQUIREMENTS OF THEIR INTENDED USE. OMRON DISCLAIMS ALL OTHER WARRANTIES, EXPRESS OR IMPLIED.

### LIMITATIONS OF LIABILITY

OMRON SHALL NOT BE RESPONSIBLE FOR SPECIAL, INDIRECT, OR CONSEQUENTIAL DAMAGES, LOSS OF PROFITS OR COMMERCIAL LOSS IN ANY WAY CONNECTED WITH THE PRODUCTS, WHETHER SUCH CLAIM IS BASED ON CONTRACT, WARRANTY, NEGLIGENCE, OR STRICT LIABILITY.

In no event shall the responsibility of OMRON for any act exceed the individual price of the product on which liability is asserted.

IN NO EVENT SHALL OMRON BE RESPONSIBLE FOR WARRANTY, REPAIR, OR OTHER CLAIMS REGARDING THE PRODUCTS UNLESS OMRON'S ANALYSIS CONFIRMS THAT THE PRODUCTS WERE PROPERLY HANDLED, STORED, INSTALLED, AND MAINTAINED AND NOT SUBJECT TO CONTAMINATION, ABUSE, MISUSE, OR INAPPROPRIATE MODIFICATION OR REPAIR.

## Application Considerations

### SUITABILITY FOR USE

OMRON shall not be responsible for conformity with any standards, codes, or regulations that apply to the combination of the product in the customer's application or use of the product.

Take all necessary steps to determine the suitability of the product for the systems, machines, and equipment with which it will be used.

Know and observe all prohibitions of use applicable to this product.

NEVER USE THE PRODUCT FOR AN APPLICATION INVOLVING SERIOUS RISK TO LIFE OR PROPERTY WITHOUT ENSURING THAT THE SYSTEM AS A WHOLE HAS BEEN DESIGNED TO ADDRESS THE RISKS, AND THAT THE OMRON PRODUCT IS PROPERLY RATED AND INSTALLED FOR THE INTENDED USE WITHIN THE OVERALL EQUIPMENT OR SYSTEM.

### PROGRAMMABLE PRODUCTS

OMRON shall not be responsible for the user's programming of a programmable product, or any consequence thereof.

## Disclaimers

### CHANGE IN SPECIFICATIONS

Product specifications and accessories may be changed at any time based on improvements and other reasons. Consult with your OMRON representative at any time to confirm actual specifications of purchased product.

### DIMENSIONS AND WEIGHTS

Dimensions and weights are nominal and are not to be used for manufacturing purposes, even when tolerances are shown.

### PERFORMANCE DATA

Performance data given in this catalog is provided as a guide for the user in determining suitability and does not constitute a warranty. It may represent the result of OMRON's test conditions, and the users must correlate it to actual application requirements. Actual performance is subject to the OMRON Warranty and Limitations of Liability.

**Note: Do not use this document to operate the Unit.**

**OMRON Corporation Industrial Automation Company**  
Tokyo, JAPAN

**Contact: [www.ia.omron.com](http://www.ia.omron.com)**

**Regional Headquarters**

**OMRON EUROPE B.V.**

Wegalaan 67-69-2132 JD Hoofddorp  
The Netherlands  
Tel: (31)2356-81-300/Fax: (31)2356-81-388

**OMRON ELECTRONICS LLC**

One Commerce Drive Schaumburg,  
IL 60173-5302 U.S.A.  
Tel: (1) 847-843-7900/Fax: (1) 847-843-7787

**OMRON ASIA PACIFIC PTE. LTD.**

No. 438A Alexandra Road # 05-05/08 (Lobby 2),  
Alexandra Technopark,  
Singapore 119967  
Tel: (65) 6835-3011/Fax: (65) 6835-2711

**OMRON (CHINA) CO., LTD.**

Room 2211, Bank of China Tower,  
200 Yin Cheng Zhong Road,  
PuDong New Area, Shanghai, 200120, China  
Tel: (86) 21-5037-2222/Fax: (86) 21-5037-2200

**Authorized Distributor:**

© OMRON Corporation 2009 All Rights Reserved.  
In the interest of product improvement,  
specifications are subject to change without notice.

**Cat. No. P061-E1-04**

0210 (0309)